

serrat



PRICE LIST



serrat





SERRAT MULCHERS

SERRAT MULCHERS is a company dedicated to the manufacturing of forester and agricultural grinding machines, industrial gardening and public works.

Our wide range of products makes us leaders of the agricultural and forester grinding machines sector.

We are a company, founded on 1998, now with more than 70 qualified employees with a vast experience in the products the manufacture.

Our Engineering Team is equipped with CAD-CAM systems, offering us the possibility to customize products to the unit.

The factory, with more than 5.000 m² covered, is equipped with the latest technologies for mechanical manufacturing, besides a rigorous quality control system, to faithfully reproduce the specifications demanded by the client and

designed by our engineers.

We have an extensive network of sales at worldwide level.

Besides the manufacture of crushers, the company offers after sales service, spare parts and repairs for all direct and personal customers and distributors.

Customers with personalized service to every customer by helping you define your product according to specific technical needs; we can say that SERRAT MULCHERS is another way to grind.

SERRAT ANSWERS; trust in SERRAT is a safe bet, guaranteeing the complete after-sales service during the machine life.



VALUES IN SURE GROUND

S Professionalism and Integrity: The uninterrupted development and study by our technological I+D department, ensure to every client a unique adaptation to their needs. Our machines have been designed by powerful 3D programs with the most innovative systems.

E ffectiveness: Besides our rigorous quality control, SERRAT MULCHERS possesses a professional team for efficiency and operation field testing of their prototypes under limiting and tough conditions.

R esponsibility and professionalism: Our products are manufactured in technical plate (ablative, high yield stress, etc.), standard hammers guaranteed against breakage MAR-001 with safety indications visible to personnel.

R Continuous Renovation: We always want the best and we know that everything is improvable. For that we don't stop, we're always thinking and developing new models that could adapt better in different situations.

A Improving Attitude: We face any kind of problems like a new challenge to overcome. Always learning and improving.

T Quality work: All models are built under EC regulations.

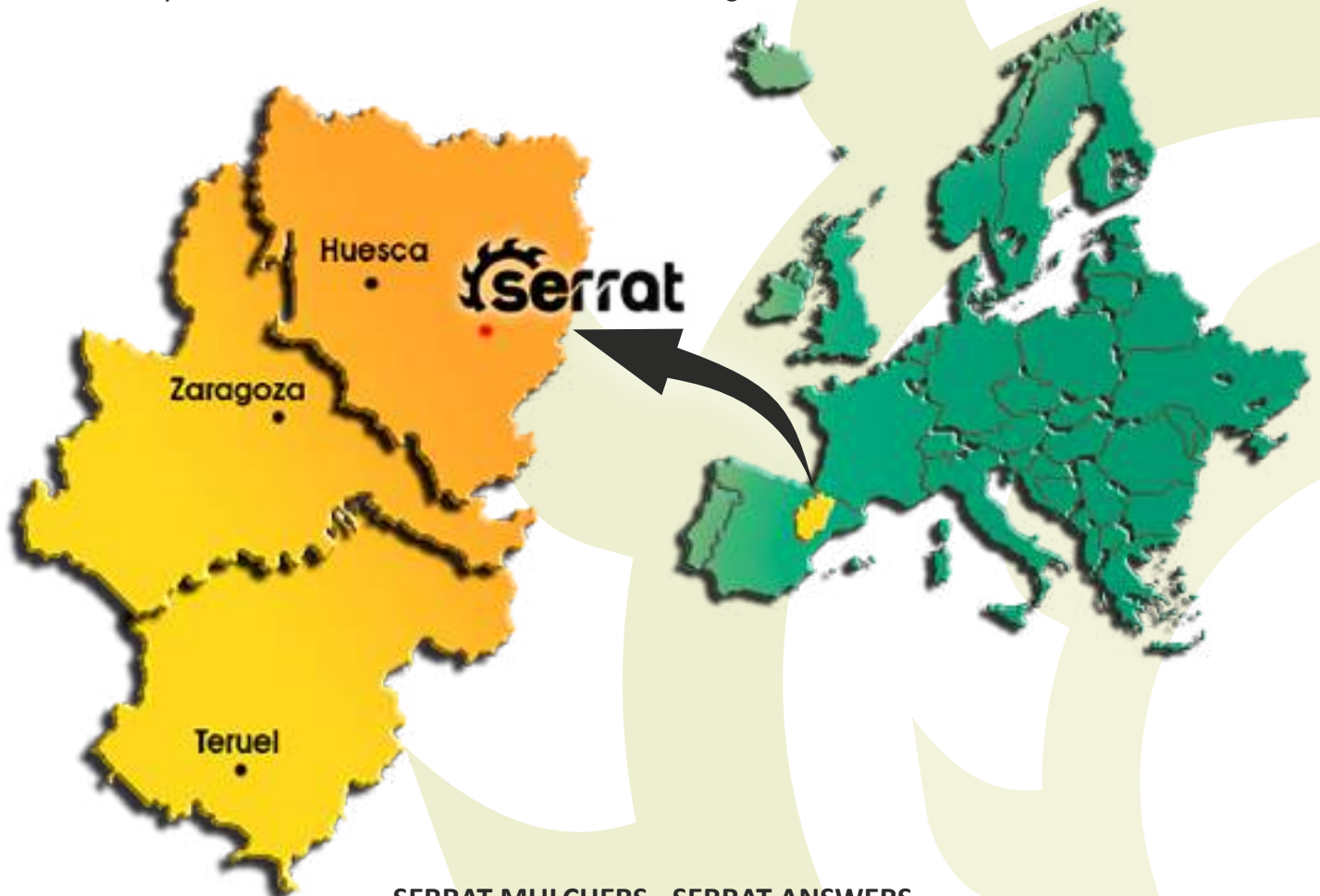



**SALES
DEPARTMENT**

Pedro Serrat



General Sales Manager

(+34) 649 191 050
pedro@serrat.es

Joaquín Serena



Sales Manager
Spain and Portugal

(+34) 619 226 117
joaquin@serrat.es

Mario Paredes



Sales Spain

(+34) 683 630 563
m.paredes@serrat.es

Laure Béraud



Export Sales Manager France

Spain: (+34) 616 506 218
France: (+33) 668 193 926
l.beraud@serrat.es

Pablo Serna



Sales France

(+34) 636 437 987
p.serna@serrat.es



SALES DEPARTMENT

Alessandro Fagnani



Export Sales Manager

Spain: (+34) 646 257 191
Italy: (+39) 347 4133 836
alessandro@serrat.es

Zhanna Siamko



Export Sales Manager

(+34) 686 889 832
zhanna@serrat.es

Cristina Serrat



Sales North and South America

(+34) 689 774 258
cristina@serrat.es

Pablo Serrat



After Sales and Quality
Service Manager
(English)

(+34) 974 417 830
technicalservice@serrat.es

Alejandro Conesa



After Sales and Quality
Service Manager
(Spanish)

(+34) 974 417 830
serviciotecnico@serrat.es

Nicolás Boutonnet



After Sales and Quality Service
Manager Export
(French)

(+34) 974 417 830
recambios@serrat.es

Agricultural Range **9**

PT	10
IBP	11
TRIGON FIXED.....	12
TRIGON SIDE SHIFT	13
TRIGON REVERSIBLE SIDE SHIFT.....	14
EVOLUTION FIXED	15
EVOLUTION FIXED REAR HOOD	16
EVOLUTION SIDE SHIFT	17
EVOLUTION SIDE SHIFT REAR HOOD.....	18
EVOLUTION REVERSIBLE SIDE SHIFT	19
EVOLUTION GREEN.....	20
PRO FIXED.....	21
PRO FIXED REAR HOOD.....	22
PRO SIDE SHIFT	23
PRO SIDE SHIFT REAR HOOD	24
PRO REVERSIBLE.....	25
PRO REVERSIBLE SIDE SHIFT	26
VIÑA.....	27
PRO + FIXED	28
PRO + SIDE SHIFT.....	29
PRO + REVERSIBLE SIDE SHIFT	30
WOLKAVIA	31
MAYDER.....	32
MAYDER +	33
ABATIBLE EVOLUTION	34
ABATIBLE PRO +.....	35
ABATIBLE SUPER +	36
LEYKAZA	37
IBP FRONTAL.....	38
EVOLUTION FRONTAL.....	39
INTERPIQUET	40
INTERPIQUET HIGH CUT	41
INTERPIQUET DOBLE	42
OLI VINA.....	43
OLI 450	44
SPLINTER 350.....	45
SPLINTER 450.....	46
SPLINTER 550.....	47
KASTOR 350.....	48
KASTOR 450.....	49
KASTOR 550.....	50
KASTOR 625.....	51

Forestry Range **53**

FX-3.....	54
FX	55
FX +	56
FX-5.....	57
FX-6.....	58
FX-8.....	59
CADENAS JUNIOR	60
FX CS	61
FX CADENAS.....	62

Soil Range **63**

FARMLAND-3	64
FARMLAND-4	65
FARMLAND-5	66
HARDLAND.....	67
TILLER-3	68
TILLER	69
TILLER +	70
TILLER + 700.....	71
TOTEM-4.....	72
PICAPIEDRAS	73

Hydraulic Heads **75**

CABEZAL F1	76
CABEZAL F2	77
CABEZAL F3	78
CABEZAL F4	79
CABEZAL F5	80
CABEZAL MF-2.....	81
CABEZAL MF-3.....	82

Green Spaces Range **83**

MINI DAP.....	84
DAP EVOLUTION	85
DAP +	86
DAP FX.....	87

Biomass Range **89**

TRIGON PACK	90
PRO PACK	91
BIOMASS 100.....	92
BIOMASS 150.....	93
BIOMASS 200.....	94
BIOMASS 400.....	95
BIOGREEN	96
BIOSYLVA	97

Other apps **98**

TURBINA 330	98
-------------------	----

Agricultural Range

Serrrat

PT



GIROSTOP

SEKURLAST









CHARACTERISTICS

- ▶ Steel-plate chassis, thickness 4 mm.
- ▶ Tubular rotor of Ø 350 mm.
- ▶ Gearbox with freewheel included.
- ▶ 3 XPB side belt transmission.
- ▶ Forged hammers SERRAT.
- ▶ 2 lines of counter knives screwed.
- ▶ GIROSTOP system into the bolt of the hammer.
- ▶ Supports of bearing rotor in steel.
- ▶ High speed and high strength bearings.
- ▶ Turret to be hooked in several positions.
- ▶ PTO 540 rpm.
- ▶ Double bearing on rear roller.
- ▶ Rear height-adjustable roller Ø 140 mm.
- ▶ Model built under EC Normative.
- ▶ Safety indicators visible to personnel.

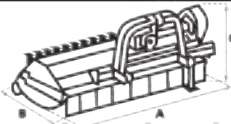

MODEL

MODEL					N.º BELTS TYPE								PRICE
						A mm	A in	B mm	B in	C mm	C in		
T-1200	1200	15 - 20 30 - 40	16	260	3 XPB	1276	50"	895	35"	828	33"	540	4.224 €
T-1400	1400	18 - 25 30 - 40	16	275	3 XPB	1476	58"	895	35"	828	33"	540	4.607 €
T-1600	1600	26 - 35 30 - 40	20	295	3 XPB	1676	66"	895	35"	828	33"	540	5.120 €

ACCESSORIES







Hydraulic side shift	602 €	Front adjustable skid shoes (2) only for straight side	179 €
Rear gum (by metre)	179 €		



CHARACTERISTICS

- ▶ Steel-plate chassis, thickness 6 mm.
- ▶ Tubular rotor of Ø 400 mm.
- ▶ Gearbox with freewheel included.
- ▶ 3 XPB side belt transmission.
- ▶ Forged hammers SERRAT special "grass".
- ▶ 2 lines of counter knives screwed.
- ▶ GIROSTOP system into the bolt of the hammer.
- ▶ Supports of bearing rotor in steel.
- ▶ High speed and high strength bearings.
- ▶ PTO 540 rpm.
- ▶ Double bearing on rear roller.
- ▶ Height-adjustable rear roller Ø 180 mm.
- ▶ Width cover belts 84 mm.
- ▶ Model built under EC Normative.
- ▶ Safety indicators visible to personnel.

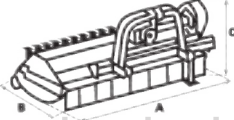

MODEL	 mm	 KW-HP		 KG	N° BELTS TYPE								PRICE
						A mm	A in	B mm	B in	C mm	C in		
T-900	900	22 - 30 60 - 80	8	320	3 XPB	1075	42"	1130	44"	1000	39"	540	4.864 €
T-1200	1200	30 - 40 60 - 80	9	365	3 XPB	1375	54"	1130	44"	1000	39"	540	5.120 €
T-1400	1400	34 - 45 60 - 80	12	395	3 XPB	1575	62"	1130	44"	1000	39"	540	5.376 €
T-1600	1600	37 - 50 60 - 80	12	418	3 XPB	1775	70"	1130	44"	1000	39"	540	5.760 €
T-1800	1800	45 - 60 60 - 80	16	430	3 XPB	1975	71"	1130	44"	1000	39"	540	6.272 €
T-2000	2000	52 - 70 60 - 80	16	476	3 XPB	2175	86"	1130	44"	1000	39"	540	6.912 €

ACCESSORIES

Hydraulic side shift (from T-1200)	576 €	Rear gum (by metre)	179 €
Rounded side	550 €	Front adjustable skid shoes (2) only for straight side	179 €
Rear tine retainers (by metre)	269 €		

Serrrat

TRIGON FIXED







GIROSTOP
SEKURLAST

CHARACTERISTICS

- ▶ Steel-plate chassis, thickness 8 mm.
- ▶ Tubular rotor of Ø 420 mm.
- ▶ Gearbox SERRAT.
- ▶ 3 XPC side belt transmission.
- ▶ Forged agricultural hammers SERRAT.
- ▶ Hammers guaranteed against breakage.
- ▶ GIROSTOP system into the bolt of the hammer.
- ▶ Supports of bearing rotor in steel.
- ▶ High speed and high strength bearings.
- ▶ Front protection curtain.
- ▶ System antiwire in rotor.
- ▶ Double bearing on rear roller.
- ▶ Rear height-adjustable roller Ø 180 mm.
- ▶ PTO 540 rpm.
- ▶ Rear roller cleaner.
- ▶ Steel counter hammers.
- ▶ Model built under EC Normative.
- ▶ Safety indicators visible to personnel.

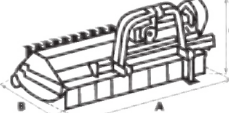

MODEL

					N° BELTS TYPE								PRICE
	mm	KW-HP				A mm	A in	B mm	B in	C mm	C in		
T-1100	1100	29 - 40 60 - 80	8	416	3 XPC	1295	51"	1230	48"	868	34"	540	6.144 €
T-1250	1250	33 - 45 60 - 80	12	453	3 XPC	1445	57"	1230	48"	868	34"	540	6.400 €
T-1400	1400	38 - 50 60 - 80	12	478	3 XPC	1595	63"	1230	48"	868	34"	540	6.656 €
T-1600	1600	40 - 55 60 - 80	12	510	3 XPC	1795	71"	1230	48"	868	34"	540	6.912 €
T-1800	1800	44 - 60 60 - 80	16	555	3 XPC	1995	79"	1230	48"	868	34"	540	7.167 €
T-2000	2000	51 - 70 60 - 80	16	587	3 XPC	2195	86"	1230	48"	868	34"	540	7.424 €

ACCESSORIES

Rear wheels kit	550 €	Freewheel	630 €
Front wheels kit	550 €	Front chains (by metre)	167 €
Front adjustable skid shoes (2)	281 €	Rear tine retainers (by metre)	269 €









CHARACTERISTICS

- ▶ Steel-plate chassis, thickness 8 mm.
- ▶ Tubular rotor of Ø 420 mm.
- ▶ Gearbox SERRAT.
- ▶ 3 XPC side belt transmission.
- ▶ Forged agricultural hammers SERRAT.
- ▶ Hammers guaranteed against breakage.
- ▶ GIROSTOP system into the bolt of the hammer.
- ▶ Supports of bearing rotor in steel.
- ▶ High speed and high strength bearings.
- ▶ Front protection curtain.
- ▶ System antiwire in rotor.
- ▶ Double bearing on rear roller.
- ▶ Rear height-adjustable roller Ø 180 mm.
- ▶ PTO 540 rpm.
- ▶ Rear roller cleaner.
- ▶ Steel counter hammers.

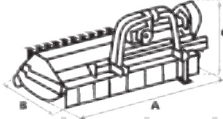

- ▶ Model built under EC Normative.
- ▶ Safety indicators visible to personnel.

MODEL

MODEL	 mm	 KW-HP		 KG	N° BELTS TYPE								PRICE
						A mm	A in	B mm	B in	C mm	C in		
T-1250	1250	33 - 45 59 - 80	12	472	3 XPC	1441	57"	1270	50"	867	34"	540	6.656 €
T-1400	1400	37 - 50 59 - 80	12	495	3 XPC	1591	63"	1270	50"	867	34"	540	6.784 €
T-1600	1600	40 - 55 59 - 80	12	525	3 XPC	1791	71"	1270	50"	867	34"	540	7.040 €
T-1800	1800	44 - 60 59 - 80	16	571	3 XPC	1991	78"	1270	50"	867	34"	540	7.295 €
T-2000	2000	51 - 70 59 - 80	16	601	3 XPC	2191	86"	1270	50"	867	34"	540	7.680 €

ACCESSORIES

Rear wheels kit	550 €	Freewheel	630 €
Front wheels kit	550 €	Front chains (by metre)	167 €
Front adjustable skid shoes (2)	281 €	Rear tine retainers (by metre)	269 €

Serrrat

TRIGON REVERSIBLE SIDE SHIFT









CHARACTERISTICS

- ▶ Steel-plate chassis, thickness 8 mm.
- ▶ Tubular rotor of Ø 420 mm.
- ▶ Gearbox SERRAT.
- ▶ 3 XPC side belt transmission.
- ▶ Forged agricultural hammers SERRAT.
- ▶ Hammers guaranteed against breakage.
- ▶ GIROSTOP system into the bolt of the hammer.
- ▶ Supports of bearing rotor in steel.
- ▶ High speed and high strength bearings.
- ▶ Front protection curtain.
- ▶ System antiwire in rotor.
- ▶ Double bearing on rear roller.
- ▶ Rear height-adjustable roller Ø 180 mm.
- ▶ PTO 540 rpm.
- ▶ Rear roller cleaner.
- ▶ Steel counter hammers.
- ▶ Model built under EC Normative.
- ▶ Safety indicators visible to personnel.

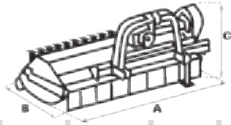

MODEL

MODEL	 mm	 KW-HP		 KG	N° BELTS TYPE								PRICE
						A mm	A in	B mm	B in	C mm	C in		
T-1400	1400	37 - 50 59 - 80	12	600	3 XPC	1591	63"	1196	47"	867	34"	540	7.552 €
T-1600	1600	40 - 55 59 - 80	12	630	3 XPC	1791	71"	1196	47"	867	34"	540	7.808 €
T-1800	1800	44 - 60 59 - 80	16	672	3 XPC	1991	78"	1196	47"	867	34"	540	8.447 €
T-2000	2000	51 - 70 59 - 80	16	703	3 XPC	2191	86"	1196	47"	867	34"	540	8.703 €

ACCESSORIES







Rear wheels kit	550 €	Freewheel	630 €	Rear tine retainers (by metre)	269 €
Front wheels kit	550 €	Front chains (by metre)	167 €	Gearbox 1.000 RPM for front PTO	806 €
Front adjustable skid shoes (2)	281 €				

CHARACTERISTICS

- ▶ Steel-plate chassis, thickness 10 mm.
- ▶ Rotor POLSER of Ø 450/500 mm.
- ▶ Gearbox SERRAT.
- ▶ 3 XPC side belt transmission.
- ▶ Forged agricultural hammers SERRAT.
- ▶ GIROSTOP system into the bolt of the hammer.
- ▶ Supports of bearing rotor in steel.
- ▶ High speed and high strength bearings.
- ▶ Front protection curtain.
- ▶ System antiwire in rotor.
- ▶ Double bearing on rear roller.
- ▶ Rear height-adjustable roller Ø 180 mm (210 mm from T-2300).
- ▶ PTO 540 rpm (1000 rpm from T-2500).
- ▶ Rear roller cleaner.

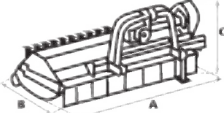

- ▶ Steel counter hammers.
- ▶ Model built under EC Normative.
- ▶ Safety indicators visible to personnel.

MODEL					N° BELTS TYPE								PRICE	
						A mm	A in	B mm	B in	C mm	C in			
450 POLSER	T-1600	1600	45 - 60 90 - 120	12	612	3 XPC	1790	70"	1180	46"	1000	39"	540	7.552 €
	T-1800	1800	48 - 65 90 - 120	16	662	3 XPC	1990	78"	1180	46"	1000	39"	540	7.808 €
	T-2000	2000	51 - 70 90 - 120	16	708	3 XPC	2190	86"	1230	48"	1000	39"	540	8.447 €
	T-2300	2300	59 - 80 90 - 120	20	812	3 XPC	2490	98"	1230	48"	1000	39"	540	8.832 €
500 POLSER	T-2500	2500	66 - 90 90 - 120	20	937	3 XPC	2690	106"	1290	51"	1000	39"	1000	9.472 €
	T-2800	2800	81 - 110 90 - 120	24	1025	3 XPC	2990	118"	1290	51"	1000	39"	1000	9.855 €

*In the ETT version it will not possible to have rear tine retainers, roller cleaner and height-adjustable roller.

ACCESSORIES

Rear wheels kit	550 €	Freewheel	630 €	Rear tine retainers (by metre)	269 €
Front wheels kit	550 €	Front chains (by metre)	167 €	ETT	Free of charge
Front adjustable skid shoes (2)	281 €				

Serrrat

EVOLUTION FIXED REAR HOOD









CHARACTERISTICS

- ▶ Steel-plate chassis, thickness 10 mm.
- ▶ Rotor POLSER of Ø 450 mm.
- ▶ Gearbox SERRAT.
- ▶ 3 XPC side belt transmission.
- ▶ Forged agricultural hammers SERRAT.
- ▶ GIROSTOP system into the bolt of the hammer.
- ▶ Supports of bearing rotor in steel.
- ▶ High speed and high strength bearings.
- ▶ Front protection curtain.
- ▶ System antiwire in rotor.
- ▶ Double bearing on rear roller.
- ▶ Rear height-adjustable roller Ø 180 mm.
- ▶ PTO 540 rpm.
- ▶ Rear roller cleaner.
- ▶ Steel counter hammers.
- ▶ Rear hydraulic hood with sieve.
- ▶ Front skid shoes.

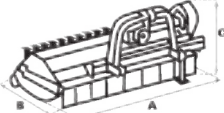

- ▶ Model built under EC Normative.
- ▶ Safety indicators visible to personnel.

MODEL	 mm	 KW-HP		 KG	N° BELTS TYPE								PRICE
						A mm	A in	B mm	B in	C mm	C in		
T-1600	1600	44 - 60 88 - 120	12	612	3 XPC	1790	70"	1180	46"	1000	39"	540	10.240 €
T-1800	1800	48 - 65 88 - 120	16	662	3 XPC	1990	78"	1180	46"	1000	39"	540	10.496 €
T-2000	2000	51 - 70 88 - 120	16	708	3 XPC	2190	86"	1230	48"	1000	39"	540	11.007 €
T-2300	2300	59 - 80 88 - 120	20	812	3 XPC	2490	98"	1230	48"	1000	39"	540	11.391 €

ACCESSORIES







Freewheel

630 €

CHARACTERISTICS

- ▶ Steel-plate chassis, thickness 10 mm.
- ▶ Rotor POLSER of Ø 450/500 mm.
- ▶ Gearbox SERRAT.
- ▶ 3 XPC side belt transmission.
- ▶ Forged agricultural hammers SERRAT.
- ▶ GIROSTOP system into the bolt of the hammer.
- ▶ Supports of bearing rotor in steel.
- ▶ High speed and high strength bearings.
- ▶ Front protection curtain.
- ▶ System antiwire in rotor.
- ▶ Double bearing on rear roller.
- ▶ Rear height-adjustable roller Ø 180 mm (210 mm from T-2300).
- ▶ PTO 540 rpm (1000 rpm from T-2500).
- ▶ Rear roller cleaner.
- ▶ Steel counter hammers.
- ▶ Model built under EC Normative.
- ▶ Safety indicators visible to personnel.

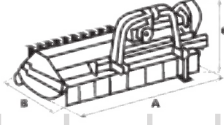

MODEL					N° BELTS TYPE								PRICE	
						mm	KW-HP	mm	A in	B mm	B in			C mm
450 POLSER	T-1400	1400	44 - 60 88 - 120	12	640	3 XPC	1570	62"	1205	47"	950	37"	540	7.552 €
	T-1600	1600	48 - 65 88 - 120	12	678	3 XPC	1790	70"	1205	47"	1040	41"	540	8.064 €
	T-1800	1800	51 - 70 88 - 120	16	730	3 XPC	1990	78"	1205	47"	1040	41"	540	8.575 €
	T-2000	2000	55 - 75 88 - 120	16	782	3 XPC	2190	86"	1205	47"	1040	41"	540	8.832 €
	T-2100	2100	59 - 80 88 - 120	16	802	3 XPC	2290	90"	1205	47"	1040	41"	540	9.088 €
	T-2300	2300	63 - 85 88 - 120	20	889	3 XPC	2490	98"	1205	47"	1040	41"	540	9.472 €
500 POLSER	T-2500	2500	70 - 95 88 - 120	20	1022	3 XPC	2690	106"	1290	51"	1320	52"	1000	9.855 €
	T-2800	2800	74 - 100 88 - 120	24	1105	3 XPC	2990	118"	1290	51"	1320	52"	1000	10.880 €

*In the ETT version it will not possible to have rear tine retainers, roller cleaner and height-adjustable roller.

ACCESSORIES

Rear wheels kit	550 €	Freewheel	630 €	Rear tine retainers (by metre)	269 €
Front wheels kit	550 €	Inclined side belt protection	474 €	V2	1.266 €
Front adjustable skid shoes (2)	281 €	Front chains (by metre)	167 €	ETT	Free of charge
Super hydraulic side shift	909 €				

Serrrat

EVOLUTION SIDE SHIFT REAR HOOD









CHARACTERISTICS

- ▶ Steel-plate chassis, thickness 10 mm.
- ▶ Rotor POLSER of Ø 450 mm.
- ▶ Gearbox SERRAT.
- ▶ 3 XPC side belt transmission.
- ▶ Forged agricultural hammers SERRAT.
- ▶ GIROSTOP system into the bolt of the hammer.
- ▶ Supports of bearing rotor in steel.
- ▶ High speed and high strength bearings.
- ▶ Front protection curtain.
- ▶ System antiwire in rotor.
- ▶ Double bearing on rear roller.
- ▶ Rear height-adjustable roller Ø 180 mm.
- ▶ PTO 540 rpm.
- ▶ Rear roller cleaner.
- ▶ Steel counter hammers.
- ▶ Rear hydraulic hood with sieve.
- ▶ Front skid shoes.
- ▶ Model built under EC Normative.
- ▶ Safety indicators visible to personnel.

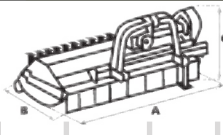

MODEL

					N° BELTS TYPE								PRICE
	mm	KW-HP				A mm	A in	B mm	B in	C mm	C in		
T-1400	1400	44 - 60 88 - 120	12	640	3 XPC	1570	62"	1205	47"	950	37"	540	10.240 €
T-1600	1600	48 - 65 88 - 120	12	678	3 XPC	1790	70"	1205	47"	1040	41"	540	10.496 €
T-1800	1800	51 - 70 88 - 120	16	730	3 XPC	1990	78"	1205	47"	1040	41"	540	11.007 €
T-2000	2000	55 - 75 88 - 120	16	782	3 XPC	2190	86"	1205	47"	1040	41"	540	11.263 €
T-2100	2100	59 - 80 88 - 120	16	802	3 XPC	2490	98"	1205	47"	1040	41"	540	11.520 €
T-2300	2300	63 - 85 88 - 120	20	889	3 XPC	2690	106"	1205	47"	1040	41"	540	11.776 €

ACCESSORIES

Freewheel

630 €

Super hydraulic side shift

909 €



CHARACTERISTICS

- ▶ Steel-plate chassis, thickness 10 mm.
- ▶ Rotor POLSER of Ø 450/500 mm.
- ▶ Gearbox SERRAT.
- ▶ 3 XPC side belt transmission.
- ▶ Forged agricultural hammers SERRAT.
- ▶ GIROSTOP system into the bolt of the hammer.
- ▶ Supports of bearing rotor in steel.
- ▶ High speed and high strength bearings.
- ▶ Front protection curtain.
- ▶ System antiwire in rotor.
- ▶ Double bearing on rear roller.
- ▶ Rear height-adjustable roller Ø 180 mm (210 mm from T-2300).



- ▶ PTO 540 rpm (1000 rpm from T-2500).
- ▶ 1000 rpm for front PTO.
- ▶ Rear roller cleaner.
- ▶ Steel counter hammers.
- ▶ Model built under EC Normative.
- ▶ Safety indicators visible to personnel.

MODEL					N° BELTS TYPE								PRICE	
						mm	KW-HP	A mm	A in	B mm	B in			C mm
450 POLSER	T-1600	1600	44 - 60 88 - 120	12	810	3 XPC	1790	70"	1450	57"	950	37"	540	8.960 €
	T-1800	1800	48 - 65 88 - 120	16	861	3 XPC	1990	78"	1450	57"	950	37"	540	9.472 €
	T-2000	2000	51 - 70 88 - 120	16	916	3 XPC	2190	86"	1450	57"	950	37"	540	9.727 €
500 POLSER	T-2300	2300	59 - 80 88 - 120	20	1023	3 XPC	2490	98"	1450	57"	950	37"	540	10.368 €
	T-2500	2500	66 - 90 88 - 120	20	1152	3 XPC	2690	106"	1450	57"	980	39"	1000	11.007 €
	T-2800	2800	74 - 100 88 - 120	24	1235	3 XPC	2990	118"	1450	57"	980	39"	1000	11.648 €

ACCESSORIES

Rear wheels kit	550 €	Green	3.149 €	Super hydraulic side shift	909 €
Front wheels kit	550 €	Front chains (by metre)	167 €	Gearbox 1.000 RPM for front PTO	806 €
Front adjustable skid shoes (2)	281 €	Rear tine retainers (by metre)	269 €	Reinforced roller (by metre)	206 €
Freewheel	630 €				

Serrrat

EVOLUTION GREEN







450 POLSER  GIROSTOP  SEKURLAST 

CHARACTERISTICS

- ▶ Steel-plate chassis, thickness 8 mm.
- ▶ Rotor POLSER of Ø 450 mm.
- ▶ Gearbox SERRAT.
- ▶ 3 XPC side belt transmission.
- ▶ Forged hammers SERRAT special "grass".
- ▶ GIROSTOP system into the bolt of the hammer.
- ▶ Supports of bearing rotor in steel.
- ▶ High speed and high strength bearings.
- ▶ Front protection curtain.
- ▶ System antiwire in rotor.
- ▶ Double bearing on rear roller.
- ▶ Rear height-adjustable roller Ø 180 mm (210 mm from T-2300).
- ▶ PTO 540 rpm.
- ▶ Steel counter hammers.
- ▶ Rear roller cleaner.
- ▶ Model built under EC Normative.
- ▶ Safety indicators visible to personnel.

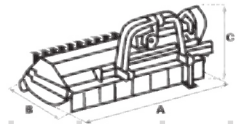

MODEL

					N° BELTS TYPE								PRICE
	mm	KW-HP		KG		A mm	A in	B mm	B in	C mm	C in		
T-1200	1200	44 - 60 88 - 120	12	720	3 XPC	1460	57"	1560	61"	1000	39"	540	10.880 €
T-1400	1400	48 - 65 88 - 120	12	790	3 XPC	1660	65"	1560	61"	1000	39"	540	11.263 €
T-1600	1600	51 - 70 88 - 120	12	840	3 XPC	1860	74"	1560	61"	1000	39"	540	11.648 €
T-1800	1800	55 - 75 88 - 120	16	900	3 XPC	2060	81"	1560	61"	1000	39"	540	11.904 €
T-2000	2000	63 - 85 88 - 120	16	957	3 XPC	2260	89"	1560	61"	1000	39"	540	12.160 €
T-2100	2100	70 - 95 88 - 120	16	980	3 XPC	2360	93"	1560	61"	1000	39"	540	12.415 €
T-2300	2300	74 - 100 88 - 120	20	1.000	3 XPC	2560	100"	1560	61"	1000	39"	540	13.056 €

ACCESSORIES







Rear wheels kit	550 €	Freewheel	630 €	Front chains (by metre)	167 €
Front wheels kit	550 €	Green X2	3.290 €	Super hydraulic side shift	909 €
Front adjustable skid shoes (2)	281 €				



CHARACTERISTICS

- ▶ Steel-plate chassis, thickness 10 mm.
- ▶ Rotor POLSER of Ø 550 mm.
- ▶ Gearbox SERRAT.
- ▶ 3/4 XPC side belt transmission.
- ▶ Forged agricultural hammers SERRAT.
- ▶ GIROSTOP system into the bolt of the hammer.
- ▶ Supports of bearing rotor in steel.
- ▶ High speed and high strength bearings.
- ▶ Front protection curtain.
- ▶ System antiwire in rotor.
- ▶ Double bearing on rear roller.
- ▶ Rear height-adjustable roller Ø 180 mm (210 mm from T-2000).
- ▶ PTO 540 rpm (1000 rpm from T-2500).
- ▶ Rear roller scraper.
- ▶ 3 lines of counter hammers.
- ▶ Model built under EC Normative.
- ▶ Safety indicators visible to personnel.

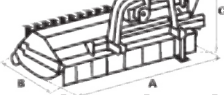
MODEL

					N° BELTS TYPE								PRICE
						mm	KW-HP	A mm	A in	B mm	B in		
T-1250	1250	44 - 60 96 - 130	12	618	3 XPC	1446	57"	1289	51"	948	37"	540	7.295 €
T-1400	1400	48 - 65 96 - 130	12	650	3 XPC	1596	63"	1289	51"	948	37"	540	7.424 €
T-1500	1500	51 - 70 96 - 130	12	680	3 XPC	1695	67"	1289	51"	948	37"	540	7.552 €
T-1600	1600	55 - 75 96 - 130	12	705	3 XPC	1796	71"	1289	51"	954	38"	540	7.808 €
T-1800	1800	59 - 80 96 - 130	16	770	3 XPC	1997	79"	1298	51"	954	38"	540	8.192 €
T-2000	2000	63 - 85 96 - 130	16	888	4 XPC	2206	87"	1344	53"	1056	42"	540	9.983 €
T-2300	2300	66 - 90 96 - 130	20	980	4 XPC	2506	99"	1344	53"	1106	43"	540	11.007 €
T-2500	2500	70 - 95 96 - 130	20	1038	4 XPC	2706	106"	1344	53"	1120	44"	1000	12.415 €
T-2800	2800	74 - 100 96 - 130	28	1188	4 XPC	3005	118"	1344	53"	1164	46"	1000	13.312 €
T-3000	3000	79 - 105 96 - 130	32	1280	4 XPC	3237	127"	1344	53"	1164	46"	1000	13.695 €
T-3200	3200	81 - 110 96 - 130	32	1388	4 XPC	3437	135"	1344	53"	1164	46"	1000	14.500 €

ACCESSORIES

Front gums (by metre)	153 €	Freewheel	630 €	Reinforced roller (by metre)	206 €
Rear gum (by metre)	167 €	Front chains (by metre)	167 €	Green x1 - 2100 mm	4.096 €
Front adjustable skid shoes (2)	371 €	Rear tine retainers (by metre)	269 €	Green x1 - 2800 mm	4.749 €
Preparation for vineyard (bodywork)	474 €			Green x2 - 2100 mm	8.474 €

Serrrat

PRO FIXED REAR HOOD

550
POLSER

GIROSTOP



SEKURLAST







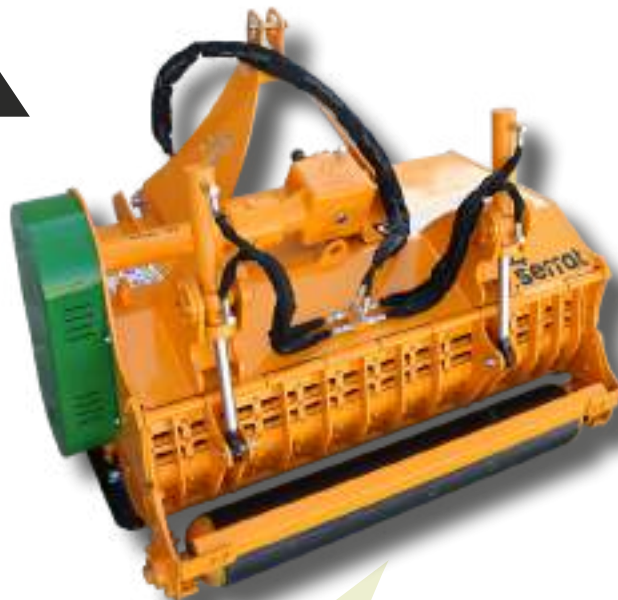

CHARACTERISTICS

- ▶ Steel-plate chassis, thickness 10 mm.
 - ▶ Rotor POLSER of Ø 550 mm.
 - ▶ Gearbox SERRAT.
 - ▶ 3/4 XPC side belt transmission.
 - ▶ Forged agricultural hammers SERRAT.
 - ▶ GIROSTOP system into the bolt of the hammer.
 - ▶ Supports of bearing rotor in steel.
 - ▶ High speed and high strength bearings.
 - ▶ Front protection curtain.
 - ▶ System antiwire in rotor.
 - ▶ Double bearing on rear roller.
 - ▶ Rear height-adjustable roller Ø 210 mm.
 - ▶ PTO 540 rpm.
 - ▶ Rear hydraulic hood with sieve.
- ▶ Rear roller cleaner.
 - ▶ 11 lines of counter hammers.
 - ▶ Front skid shoes.
 - ▶ Model built under EC Normative.
 - ▶ Safety indicators visible to personnel.

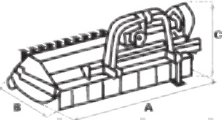

MODEL

MODEL					N° BELTS TYPE								PRICE
	mm	KW-HP				A mm	A in	B mm	B in	C mm	C in		
T-1400	1400	48 - 65 96 - 130	12	853	3 XPC	1621	64"	1345	53"	1150	45"	540	10.496 €
T-1500	1500	51 - 70 96 - 130	12	880	3 XPC	1721	68"	1345	53"	1150	45"	540	11.007 €
T-1600	1600	55 - 75 96 - 130	12	913	3 XPC	1821	72"	1345	53"	1150	45"	540	11.263 €
T-1800	1800	59 - 80 96 - 130	16	986	3 XPC	2021	80"	1345	53"	1150	45"	540	11.648 €
T-2000	2000	63 - 85 96 - 130	16	1079	4 XPC	2221	87"	1345	53"	1150	45"	540	13.056 €
T-2300	2300	66 - 90 96 - 130	20	1175	4 XPC	2521	99"	1345	53"	1150	45"	540	13.823 €

ACCESSORIES

Adjustable wheels kit	1.177 €	Freewheel	630 €
Reinforced roller (by metre)	206 €		
Rear hydraulic hood without sieve	Free of charge		









CHARACTERISTICS

- ▶ Steel-plate chassis, thickness 10 mm.
- ▶ Rotor POLSER of Ø 550 mm.
- ▶ Gearbox SERRAT.
- ▶ 3/4 XPC side belt transmission.
- ▶ Forged agricultural hammers SERRAT.
- ▶ GIROSTOP system into the bolt of the hammer.
- ▶ Supports of bearing rotor in steel.
- ▶ High speed and high strength bearings.
- ▶ Front protection curtain.
- ▶ System antiwire in rotor.
- ▶ Double bearing on rear roller.
- ▶ Rear height-adjustable roller Ø 180 mm (210 mm from T-2000).
- ▶ PTO 540 rpm (1000 rpm from T-2500).
- ▶ Rear roller scraper.
- ▶ 3 lines of counter hammers.
- ▶ Model built under EC Normative.
- ▶ Safety indicators visible to personnel.

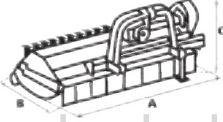

MODEL

MODEL	 mm	 KW-HP		 KG	N° BELTS TYPE								PRICE
						A mm	A in	B mm	B in	C mm	C in		
T-1400	1400	48 - 65 96 - 130	12	750	3 XPC	1596	63"	1275	50"	1070	42"	540	8.192 €
T-1500	1500	51 - 70 96 - 130	12	775	3 XPC	1695	67"	1275	50"	1070	42"	540	8.703 €
T-1600	1600	55 - 75 96 - 130	12	800	3 XPC	1796	71"	1275	50"	1070	42"	540	9.088 €
T-1800	1800	59 - 80 96 - 130	16	860	3 XPC	1997	79"	1275	50"	1070	42"	540	9.472 €
T-2000	2000	63 - 85 96 - 130	16	1003	4 XPC	2206	87"	1329	52"	1070	42"	540	11.263 €
T-2300	2300	66 - 90 96 - 130	20	1077	4 XPC	2506	99"	1329	52"	1070	42"	540	11.904 €
T-2500	2500	70 - 95 96 - 130	20	1135	4 XPC	2706	106"	1329	52"	1070	42"	1000	13.312 €
T-2800	2800	74 - 100 96 - 130	28	1330	4 XPC	3028	119"	1329	52"	1070	42"	1000	13.951 €

ACCESSORIES

Front gums (by metre)	153 €	Freewheel	630 €	Front chains (by metre)	167 €
Rear gum (by metre)	167 €	Green x1	4.096 €	Rear tine retaines (by metre)	269 €
Front adjustable skid shoes (2)	371 €	Green x2	8.474 €	Reinforced roller (by metre)	206 €
Preparation for vineyard (bodywork)	474 €	Frontal with side shift	2.625 €	Gearbox 1.000 RPM for front PTO	806 €

Serrrat

PRO SIDE SHIFT REAR HOOD

CHARACTERISTICS









- ▶ Steel-plate chassis, thickness 10 mm.
- ▶ Rotor POLSER of Ø 550 mm.
- ▶ Gearbox SERRAT.
- ▶ 3/4 XPC side belt transmission.
- ▶ Forged agricultural hammers SERRAT.
- ▶ GIROSTOP system into the bolt of the hammer.
- ▶ Supports of bearing rotor in steel.
- ▶ High speed and high strength bearings.
- ▶ Front protection curtain.
- ▶ System antiwire in rotor.
- ▶ Double bearing on rear roller.
- ▶ Rear height-adjustable roller Ø 210 mm.
- ▶ PTO 540 rpm (1000 rpm from T-2500).
- ▶ Rear hydraulic hood with sieve.
- ▶ Rear roller cleaner.

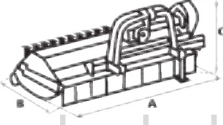

- ▶ 11 lines of counter hammers.
- ▶ Front skid shoes.
- ▶ Hydraulic lateral offset.
- ▶ Model built under EC Normative.
- ▶ Safety indicators visible to personnel.

MODEL

					N° BELTS TYPE								PRICE
	mm	KW-HP				A mm	A in	B mm	B in	C mm	C in		
T-1500	1500	51 - 70 96 - 130	12	960	3 XPC	1721	68"	1345	53"	1147	45"	540	12.032 €
T-1600	1600	55 - 75 96 - 130	12	991	3 XPC	1821	72"	1345	53"	1147	45"	540	12.287 €
T-1800	1800	59 - 80 96 - 130	16	1073	3 XPC	2021	80"	1345	53"	1147	45"	540	12.543 €
T-2000	2000	63 - 85 96 - 130	16	1164	4 XPC	2221	87"	1345	53"	1147	45"	540	14.079 €
T-2300	2300	66 - 90 96 - 130	20	1238	4 XPC	2521	99"	1345	53"	1147	45"	540	14.847 €
T-2500	2500	70 - 95 96 - 130	20	1325	4 XPC	2721	107"	1346	53"	1148	45"	1000	16.127 €

ACCESSORIES







Adjustable wheels kit	1.177 €	Freewheel	630 €
Reinforced roller (by metre)	206 €	Super hydraulic side shift	909 €
Rear hydraulic hood without sieve	Free of charge		



CHARACTERISTICS

- ▶ Steel-plate chassis, thickness 10 mm.
- ▶ Rotor POLSER of Ø 550 mm.
- ▶ Gearbox SERRAT.
- ▶ 3/4 XPC side belt transmission.
- ▶ Forged agricultural hammers SERRAT.
- ▶ GIROSTOP system into the bolt of the hammer.
- ▶ Supports of bearing rotor in steel.
- ▶ High speed and high strength bearings.
- ▶ Front protection curtain.
- ▶ System antiwire in rotor.
- ▶ Double bearing on rear roller.
- ▶ Rear height-adjustable roller Ø 180 mm (210 mm from T-2000).
- ▶ PTO 540 rpm (1000 rpm from T-2500).
- ▶ Rear roller scraper.
- ▶ 3 lines of counter hammers.
- ▶ Model built under EC Normative.
- ▶ Safety indicators visible to personnel.

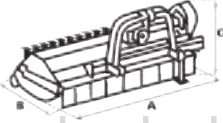
MODEL

					N° BELTS TYPE								PRICE
						A mm	A in	B mm	B in	C mm	C in		
T-1250	1250	44 - 60 96 - 130	12	680	3 XPC	1446	57"	1295	51"	1221	48"	540	8.192 €
T-1400	1400	48 - 65 96 - 130	12	718	3 XPC	1596	63"	1295	51"	1221	48"	540	8.575 €
T-1500	1500	51 - 70 96 - 130	12	746	3 XPC	1696	67"	1295	51"	1221	48"	540	8.575 €
T-1600	1600	55 - 75 96 - 130	12	783	3 XPC	1796	71"	1295	51"	1221	48"	540	8.832 €
T-1800	1800	59 - 80 96 - 130	16	844	3 XPC	1997	79"	1295	51"	1221	48"	540	9.344 €
T-2000	2000	63 - 85 96 - 130	16	960	4 XPC	2206	87"	1330	52"	1225	48"	540	11.007 €
T-2300	2300	66 - 90 96 - 130	20	1058	4 XPC	2506	99"	1330	52"	1225	48"	540	11.776 €
T-2500	2500	70 - 95 96 - 130	20	1130	4 XPC	2706	107"	1330	52"	1225	48"	1000	12.543 €

ACCESSORIES

Front gums (by metre)	153 €	Freewheel	630 €	Front chains (by metre)	167 €
Rear gum (by metre)	167 €	Green x1	4.096 €	Rear tine retainers (by metre)	269 €
Front adjustable skid shoes (2)	371 €	Green x2	8.474 €	Reinforced roller (by metre)	206 €
Preparation for vineyard (bodywork)	474 €				

Serrrat

PRO REVERSIBLE SIDE SHIFT







CHARACTERISTICS

- ▶ Steel-plate chassis, thickness 10 mm.
- ▶ Rotor POLSER of Ø 550 mm.
- ▶ Gearbox SERRAT.
- ▶ 3/4 XPC side belt transmission.
- ▶ Forged agricultural hammers SERRAT.
- ▶ GIROSTOP system into the bolt of the hammer.
- ▶ Supports of bearing rotor in steel.
- ▶ High speed and high strength bearings.
- ▶ Front protection curtain.
- ▶ System antiwire in rotor.
- ▶ Double bearing on rear roller.
- ▶ Rear height-adjustable roller Ø 180 mm (210 mm from T-2000).
- ▶ PTO 540 rpm (1000 rpm from T-2800).
- ▶ Rear roller scraper.
- ▶ 3 lines of counter hammers.
- ▶ Model built under EC Normative.
- ▶ Safety indicators visible to personnel.

550 POLSER  GIROSTOP  SEKURLAST 

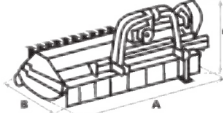

MODEL

MODEL	 mm	 KW-HP		 KG	N° BELTS TYPE								PRICE
						A mm	A in	B mm	B in	C mm	C in		
T-1500	1500	51 - 70 96 - 130	12	895	3 XPC	1696	67"	1336	53"	1080	43"	540	9.600 €
T-1600	1600	55 - 75 96 - 130	12	916	3 XPC	1796	71"	1336	53"	1080	43"	540	9.727 €
T-1800	1800	59 - 80 96 - 130	16	976	3 XPC	1997	79"	1336	53"	1080	43"	540	9.855 €
T-2000	2000	63 - 85 96 - 130	16	1105	4 XPC	2206	87"	1336	53"	1080	43"	540	11.904 €
T-2300	2300	66 - 90 96 - 130	20	1220	4 XPC	2506	99"	1336	53"	1080	43"	540	12.671 €
T-2500	2500	70 - 95 96 - 130	20	1252	4 XPC	2706	106"	1336	53"	1080	43"	540	14.079 €
T-2800	2800	74 - 100 96 - 130	28	1420	4 XPC	3006	118"	1336	53"	1080	43"	1000	14.336 €

ACCESSORIES

Front gums (by metre)	153 €	Freewheel	630 €	Front chains (by metre)	167 €
Rear gum (by metre)	167 €	Green x1	4.096 €	Rear tine retainers (by metre)	269 €
Front adjustable skid shoes (2)	371 €	Green x2	8.474 €	Reinforced roller (by metre)	206 €
Preparation for vineyard (bodywork)	474 €			Gearbox 1.000 RPM for front PTO	806 €







CHARACTERISTICS

- ▶ Steel-plate chassis, thickness 10 mm.
- ▶ Rotor POLSER of Ø 550 mm.
- ▶ Gearbox SERRAT.
- ▶ 3 XPC side belt transmission.
- ▶ Forged agricultural hammers SERRAT.
- ▶ GIROSTOP system into the bolt of the hammer.
- ▶ Supports of bearing rotor in steel.
- ▶ High speed and high strength bearings.
- ▶ Front protection curtain.
- ▶ System antiwire in rotor.
- ▶ Side plates.
- ▶ Height-adjustable wheels.
- ▶ PTO 540 rpm.
- ▶ Rear tine retainers.
- ▶ Rear gum.

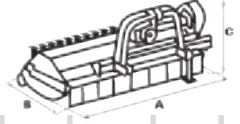

- ▶ Model built under EC Normative.
- ▶ Safety indicators visible to personnel.

MODEL

MODEL					N° BELTS TYPE								PRICE
	mm	KW-HP		KG		A mm	A in	B mm	B in	C mm	C in		
T-1100	1100	37 - 50 81 - 110	8	650	3 XPC	1350	53"	1700	67"	1130	44"	540	7.552 €
T-1250	1250	44 - 60 81 - 110	12	700	3 XPC	1500	59"	1700	67"	1130	44"	540	7.680 €
T-1500	1500	51 - 70 81 - 110	12	770	3 XPC	1750	69"	1700	67"	1130	44"	540	8.064 €
T-1600	1600	55 - 75 81 - 110	12	795	3 XPC	1850	73"	1700	67"	1130	44"	540	8.447 €
T-1800	1800	59 - 80 81 - 110	16	860	3 XPC	2050	81"	1700	67"	1130	44"	540	8.703 €
T-2000	2000	63 - 85 81 - 110	16	941	3 XPC	2250	89"	1700	67"	1130	44"	540	9.983 €
T-2300	2300	66 - 90 81 - 110	20	1035	3 XPC	2550	100"	1700	67"	1130	44"	540	11.007 €

ACCESSORIES

Adjustable wheels kit	1.177 €	Freewheel	630 €
Reinforced roller (by metre)	192 €		

Serrrat

PRO + FIXED







550 POLSER  GIROSTOP  SEKURLAST 



CHARACTERISTICS

- ▶ Steel-plate chassis, thickness 10 mm.
- ▶ Rotor POLSER of Ø 550 mm.
- ▶ Gearbox SERRAT.
- ▶ 4 XPC side belt transmission.
- ▶ Forged agricultural hammers SERRAT
- ▶ GIROSTOP system into the bolt of the hammer.
- ▶ Supports of bearing rotor in steel.
- ▶ High speed and high strength bearings.
- ▶ Front protection curtain.
- ▶ System antiwire in rotor.
- ▶ Double bearing on rear roller.
- ▶ Rear height-adjustable roller.
- ▶ PTO 1.000 rpm.
- ▶ 3 lines of counter hammers.
- ▶ Model built under EC Normative.
- ▶ Safety indicators visible to personnel.

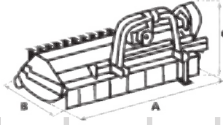
MODEL

MODEL					N° BELTS TYPE								PRICE
	mm	KW-HP				A mm	A in	B mm	B in	C mm	C in		
T-2000	2000	59 - 80 112 - 150	16	1103	4 XPC	2237	88"	1531	60"	1200	47"	1000	Consult
T-2300	2300	66 - 90 112 - 150	20	1198	4 XPC	2537	100"	1531	60"	1200	47"	1000	13.440 €
T-2500	2500	70 - 95 112 - 150	20	1260	4 XPC	2737	108"	1531	60"	1242	49"	1000	13.951 €
T-2800	2800	74 - 100 112 - 150	28	1367	4 XPC	3037	120"	1531	60"	1242	49"	1000	14.592 €
T-3000	3000	81 - 110 112 - 150	28	1424	4 XPC	3237	127"	1531	60"	1242	49"	1000	15.103 €
T-3200	3200	88 - 120 112 - 150	32	1495	4 XPC	3437	135"	1531	60"	1276	50"	1000	15.744 €
T-3600	3600	93 - 125 112 - 150	32	1594	4 XPC	3837	151"	1531	60"	1276	50"	1000	17.819 €
T-3800	3800	96 - 130 112 - 150	32	1687	4 XPC	4037	159"	1531	60"	1242	49"	1000	19.071 €
T-4000	4000	100 - 135 112 - 150	32	1744	4 XPC	4237	177"	1531	60"	1276	50"	1000	19.967 €

ACCESSORIES





Front gums (by metre)	153 €	Freewheel	630 €	Front chains (by metre)	167 €
Rear gum (by metre)	167 €	540 rpm PTO drive shaft	Free of charge	Rear tine retainers (by metre)	384 €
Front adjustable skid shoes (2)	371 €			Reinforced roller (by metre)	269 €

CHARACTERISTICS

- ▶ Steel-plate chassis, thickness 10 mm.
- ▶ Rotor POLSER of Ø 550 mm.
- ▶ Gearbox SERRAT.
- ▶ 4 XPC side belt transmission.
- ▶ Forged agricultural hammers SERRAT
- ▶ GIROSTOP system into the bolt of the hammer.
- ▶ Supports of bearing rotor in steel.
- ▶ High speed and high strength bearings.
- ▶ Front protection curtain.
- ▶ System antiwire in rotor.
- ▶ Double bearing on rear roller.

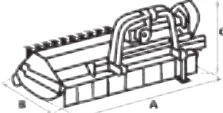

- ▶ Rear height-adjustable roller.
- ▶ PTO 1.000 rpm.
- ▶ 3 lines of counter hammers.
- ▶ Model built under EC Normative.
- ▶ Safety indicators visible to personnel.

MODEL				N° BELTS TYPE								PRICE	
	mm	KW-HP	KG		A mm	A in	B mm	B in	C mm	C in			
T-2000	2000	74 - 100 112 - 150	16	1360	4 XPC	2237	88"	1434	56"	1235	48"	1000	Consult
T-2300	2300	74 - 100 112 - 150	20	1490	4 XPC	2537	100"	1434	56"	1235	48"	1000	15.744 €
T-2500	2500	74 - 100 112 - 150	20	1528	4 XPC	2737	108"	1434	56"	1235	48"	1000	16.896 €
T-2800	2800	81 - 110 112 - 150	28	1640	4 XPC	3037	120"	1470	58"	1242	49"	1000	17.535 €
T-3000	3000	81 - 110 112 - 150	28	1600	4 XPC	3237	127"	1470	58"	1242	49"	1000	18.047 €
T-3200	3200	81 - 110 112 - 150	32	1700	4 XPC	3437	135"	1470	58"	1242	49"	1000	18.560 €
T-3600	3600	93 - 125 112 - 150	32	1594	4 XPC	3837	151"	1531	60"	1276	50"	1000	22.527 €
T-3800	3800	96 - 130 112 - 150	32	1687	4 XPC	4037	159"	1531	60"	1242	49"	1000	23.167 €

ACCESSORIES

Front gums (by metre)	153 €	Freewheel	630 €	Front chains (by metre)	167 €
Rear gum (by metre)	167 €	540 rpm PTO drive shaft	Free of charge	Rear tine retainers (by metre)	384 €
Front adjustable skid shoes (2)	371 €			Reinforced roller (by metre)	269 €

Serrrat

PRO + REVERSIBLE SIDE SHIFT









CHARACTERISTICS

- ▶ Steel-plate chassis, thickness 10 mm.
- ▶ Rotor POLSER of Ø 550 mm.
- ▶ Gearbox SERRAT.
- ▶ 4 XPC side belt transmission.
- ▶ Forged agricultural hammers SERRAT
- ▶ GIROSTOP system into the bolt of the hammer.
- ▶ Supports of bearing rotor in steel.
- ▶ High speed and high strength bearings.
- ▶ Front protection curtain.
- ▶ System antiwire in rotor.
- ▶ Double bearing on rear roller.
- ▶ Rear height-adjustable roller.
- ▶ PTO 1.000 rpm.
- ▶ 3 lines of counter hammers.

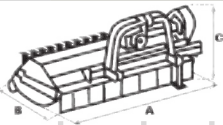

- ▶ Model built under EC Normative.
- ▶ Safety indicators visible to personnel.

MODEL					N° BELTS TYPE								PRICE
	mm	KW-HP		KG		A mm	A in	B mm	B in	C mm	C in		
T-2300	2300	66 - 90 112 - 150	20	1628	4 XPC	2553	100"	1434	56"	1200	47"	1000	17.535 €
T-2500	2500	74 - 100 112 - 150	20	1690	4 XPC	2753	108"	1434	56"	1200	47"	1000	18.687 €
T-2800	2800	81 - 110 112 - 150	28	1797	4 XPC	3053	120"	1434	56"	1200	47"	1000	19.840 €
T-3200	3200	97 - 130 112 - 150	32	1925	4 XPC	3453	136"	1434	56"	1200	47"	1000	20.223 €





ACCESSORIES

Front gums (by metre)	153 €	Freewheel	630 €	Rear tine retainers (by metre)	384 €
Rear gum (by metre)	167 €	540 rpm PTO drive shaft	Free of charge	Reinforced roller (by metre)	269 €
Front adjustable skid shoes (2)	371 €	Front chains (by metre)	167 €	Double geardrives	4.685 €
Gearbox 1.000 RPM for front PTO	806 €				

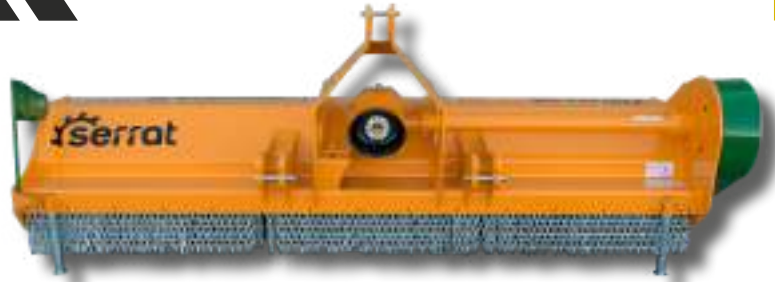
CHARACTERISTICS

- ▶ Steel-plate chassis, thickness 12 mm.
- ▶ Rotor POLSER of Ø 650 mm.
- ▶ Gearbox SERRAT 280 HP.
- ▶ 5 XPC side belt transmission.
- ▶ Forged agricultural hammers SERRAT
- ▶ GIROSTOP system into the bolt of the hammer.
- ▶ Supports of bearing rotor in steel.
- ▶ High speed and high strength bearings.
- ▶ Front protection curtain.
- ▶ System antiwire in rotor.
- ▶ Double bearing on rear roller.
- ▶ Rear height-adjustable roller; Ø 323 mm.
- ▶ PTO 1.000 rpm.
- ▶ 3 lines of counter hammers.
- ▶ Model built under EC Normative.
- ▶ Safety indicators visible to personnel.

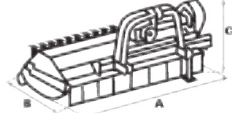

MODEL				N° BELTS TYPE								PRICE	
	mm	KW-HP	KG		A mm	A in	B mm	B in	C mm	C in			
T-2800	2800	89 - 120 149 - 200	28	1680	5 XPC	3071	121"	1570	62"	1300	51"	1000	17.663 €
T-3200	3200	89 - 120 149 - 200	32	1744	5 XPC	3471	137"	1570	62"	1300	51"	1000	18.943 €
T-3500	3500	93 - 125 150 - 240	37	1837	5 XPC	3771	148"	1570	62"	1300	51"	1000	19.967 €
T-3800	3800	97 - 130 179 - 280	37	1929	5 XPC	4071	160"	1570	62"	1300	51"	1000	21.247 €
T-4000	4000	149 - 200 179 - 280	40	2130	5 XPC	4271	168"	1570	62"	1300	51"	1000	22.143 €

ACCESSORIES

Hydraulic side shift	2.329 €	Freewheel	630 €
Double geardrives	4.941 €	Front chains (by metre)	167 €
Rear gum (by metre)	167 €		

SERRAT

MAYDER







650 POLSER  GIROSTOP  SEKURLAST 

CHARACTERISTICS

- ▶ Steel-plate chassis, thickness 8 mm.
- ▶ Rotor POLSER of Ø 650 mm.
- ▶ Gearbox SERRAT power up to 150 HP.
- ▶ 4 XPC side belt transmission.
- ▶ Stamped hammers or Y blades.
- ▶ GIROSTOP system into the bolt of the hammer.
- ▶ Supports of bearing rotor in steel.
- ▶ High speed and high strength bearings.
- ▶ Front protection curtain.
- ▶ System antiwire in rotor.
- ▶ Interchangeable counter hammers.
- ▶ Rear roller Ø 210 mm.
- ▶ PTO 1.000 rpm.



- ▶ Rear hydraulic hood.
- ▶ Model built under EC Normative.
- ▶ Safety indicators visible to personnel.

MODEL						N° BELTS TYPE								PRICE
	mm	KW-HP			KG		A mm	A in	B mm	B in	C mm	C in		
T-2300	2300	74 - 100 112 - 150	24	80	1255	4 XPC	2545	100"	1750	69"	1200	47"	1000	13.695 €
T-2500	2500	74 - 100 112 - 150	24	80	1310	4 XPC	2745	108"	1750	69"	1200	47"	1000	14.464 €
T-2800	2800	88 - 120 112 - 150	24	80	1395	4 XPC	3045	120"	1750	69"	1200	47"	1000	15.103 €
T-3200	3200	96 - 130 112 - 150	32	96	1527	4 XPC	3445	136"	1750	69"	1200	47"	1000	15.744 €

ACCESSORIES

OPTION







Adjustable wheels kit	1.946 €	Front chains (by metre)	167 €	Blades	Free of charge
Adjustable nozzle	423 €	Front adjustable skid shoes (2)	371 €	Hammers	Free of charge
Freewheel	630 €	Double geardrives	4.685 €		

CHARACTERISTICS

- ▶ Steel-plate chassis, thickness 12 mm.
- ▶ Rotor POLSER of Ø 725 mm.
- ▶ Gearbox with freewheel up to 270 HP.
- ▶ 2 x 4 XPC side belt transmission.
- ▶ Stamped hammers or Y blades.
- ▶ GIROSTOP system into the bolt of the hammer.
- ▶ Supports of bearing rotor in steel.
- ▶ High speed and high strength bearings.
- ▶ Front protection curtain.
- ▶ System antiwire in rotor.
- ▶ Double bearing on rear roller.
- ▶ Rear roller Ø 280 mm.

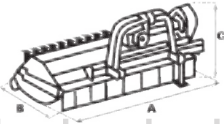

- ▶ PTO 1.000 rpm.
- ▶ Rear hydraulic hood.
- ▶ Model built under EC Normative.
- ▶ Safety indicators visible to personnel.

MODEL						N° BELTS TYPE								PRICE
	mm	KW-HP			KG		A mm	A in	B mm	B in	C mm	C in		
T-2800	2800	89 - 120 147 - 200	28	84	2316	2 x 4 XPC	3153	124"	2290	90"	1295	51"	1000	20.479 €
T-3200	3200	104 - 140 147 - 200	32	96	2510	2 x 4 XPC	3553	140"	2290	90"	1295	51"	1000	21.503 €
T-3800	3800	119 - 160 147 - 200	32	96	2845	2 x 4 XPC	4153	163"	2290	90"	1295	51"	1000	22.783 €
T-4600	4600	134 - 180 161 - 220	40	120	3150	2 x 4 XPC	4980	196"	2290	90"	1295	51"	1000	26.879 €
T-6500	6500	149 - 200 198 - 270	56	168	3430	2 x 4 XPC	6880	271"	2290	90"	1295	51"	1000	30.975 €

ACCESSORIES

Adjustable wheels kit	1.946 €	Front chains (by metre)	167 €
Adjustable nozzle	423 €	Front adjustable skid shoes (2)	371 €

OPTION

Blades	Free of charge
Hammers	Free of charge

Serrrat

ABATIBLE EVOLUTION

450 POLSER  GIROSTOP  SEKURLAST 







CHARACTERISTICS

- ▶ Steel-plate chassis, thickness 10 mm.
- ▶ Rotor POLSER of Ø 450 mm.
- ▶ Gearbox SERRAT with freewheel.
- ▶ 2 x 3 XPC side belt transmission.
- ▶ Forged agricultural hammers SERRAT
- ▶ GIROSTOP system into the bolt of the hammer.
- ▶ Supports of bearing rotor in steel.
- ▶ High speed and high strength bearings.
- ▶ Front protection curtain.
- ▶ System antiwire in rotor.
- ▶ Double bearing on rear roller.
- ▶ Rear height-adjustable rollers Ø 210 mm.
- ▶ PTO 1.000 rpm.
- ▶ Hydraulic folding exclusive design by SERRAT.

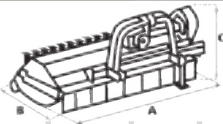

- ▶ Reversible.
- ▶ Model built under EC Normative.
- ▶ Safety indicators visible to personnel.

MODEL

MODEL					N° BELTS TYPE								PRICE
						A mm	A in	B mm	B in	C mm	C in		
T-3600	3600	74 - 100 104 - 140	16 + 16	1742	2 x 3 XPC	3700	146"	2085	82"	1220	48"	1000	23.935 €
T-4000	4000	74 - 100 104 - 140	20 + 20	1845	2 x 3 XPC	4100	161"	2085	82"	1220	48"	1000	25.215 €

ACCESSORIES

Preparation for reversible tractor. It includes front wheel	4.953 €
Extensible system	5.017 €
Rear tine retainers (by metre)	269 €









CHARACTERISTICS

- ▶ Steel-plate chassis, thickness 10 mm.
- ▶ Rotor POLSER of Ø 550 mm.
- ▶ Gearbox SERRAT with freewheel.
- ▶ 2 x 4 XPC side belt transmission.
- ▶ Forged agricultural hammers SERRAT
- ▶ GIROSTOP system into the bolt of the hammer.
- ▶ Supports of bearing rotor in steel.
- ▶ High speed and high strength bearings.
- ▶ Front protection curtain.
- ▶ System antiwire in rotor.
- ▶ Double bearing on rear roller.
- ▶ Rear height-adjustable rollers Ø 280 mm.
- ▶ PTO 1.000 rpm.
- ▶ Hydraulic folding exclusive design by SERRAT.
- ▶ Reversible.
- ▶ Rear gum over the roller.
- ▶ Model built under EC Normative.
- ▶ Safety indicators visible to personnel.

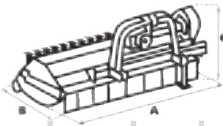

MODEL

	 mm	 KW-HP		 KG	N° BELTS TYPE								PRICE
						A mm	A in	B mm	B in	C mm	C in		
T-3800	3800	92 - 125 164 - 220	16 + 16	2574	2 x 4 XPC	3936	155"	2235	88"	1595	63"	1000	35.582 €
T-4000	4000	99 - 135 164 - 220	20 + 20	2650	2 x 4 XPC	4174	164"	2235	88"	1595	63"	1000	37.375 €
T-4800	4800	112 - 150 164 - 220	24 + 24	2900	2 x 4 XPC	4936	194"	2235	88"	1595	63"	1000	39.166 €
T-5400	5400	125 - 170 164 - 220	24 + 24	3063	2 x 4 XPC	5536	218"	2235	88"	1595	63"	1000	41.599 €
T-6300	6300	147 - 200 164 - 220	28 + 28	3334	2 x 4 XPC	6436	253"	2235	88"	1595	63"	1000	46.334 €

ACCESSORIES

Preparation for reversible tractor. It includes front wheel	4.953 €
Hydraulic safety systems for transport	1.344 €
Vertical support leg	1.294 €

Serrrat

ABATIBLE SUPER +













CHARACTERISTICS

- ▶ Steel-plate chassis, thickness 10 mm.
- ▶ Rotor POLSER of Ø 650 mm.
- ▶ Gearbox SERRAT with freewheel.
- ▶ 2X5 XPC belts transmission.
- ▶ Hydraulic starter system HIDRAHELP.
- ▶ Forged agricultural hammers SERRAT
- ▶ Hammers guaranteed against breakage.
- ▶ GIROSTOP system into the bolt of the hammer.
- ▶ Supports of bearing rotor in steel.
- ▶ High speed and high strength bearings.
- ▶ Front protection curtain.
- ▶ System antiwire in rotor.
- ▶ Double bearing on rear roller.
- ▶ Rear height-adjustable rollers Ø 325 mm.
- ▶ PTO 1.000 rpm.
- ▶ Hydraulic folding exclusive design by SERRAT.
- ▶ Reversible.
- ▶ Rear gum over the roller.
- ▶ Model built under EC Normative.
- ▶ Safety indicators visible to personnel.

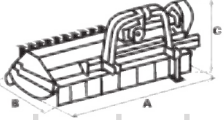

MODEL

MODEL					N° BELTS TYPE								PRICE
	mm	KW-HP		KG		A mm	A in	B mm	B in	C mm	C in		
T-6300	6300	186 - 250 298 - 400	64 + 64	5270	2 x 5 XPC	6450	254"	2860	113"	2030	80"	1000	55.038 €
T-7300	7300	186 - 250 298 - 400	64 + 64	5646	2 x 5 XPC	7450	293"	2860	113"	2030	80"	1000	59.006 €

CHARACTERISTICS

- ▶ Steel-plate chassis, thickness 8 mm.
- ▶ Rotor POLSER of Ø 600 mm.
- ▶ Gearbox SERRAT.
- ▶ Frontal machine 4 XPC belt transmission.
- ▶ Forged agricultural hammers SERRAT.
- ▶ GIROSTOP system into the bolt of the hammer.
- ▶ Supports of bearing rotor in steel.
- ▶ High speed and high strength bearings.
- ▶ Front protection curtain.
- ▶ System antiwire in rotor.
- ▶ Double bearing on rear roller.
- ▶ Rear height-adjustable rollers.
- ▶ PTO 1.000 rpm.
- ▶ Hydraulic folding exclusive design by SERRAT.
- ▶ Hidrahelp
- ▶ Rear roller Ø 280 mm.
- ▶ Freewheel.
- ▶ Direct cardan rear machine.
- ▶ Composition of two machines.
- ▶ Model built under EC Normative.
- ▶ Safety indicators visible to personnel.



MODEL					N° BELTS TYPE								PRICE
	mm	KW-HP				A mm	A in	B mm	B in	C mm	C in		
T-8400	8400	224 - 300 336 - 450	28 x 2	4560	4 XPC	8450	333"	1300	51"	1346	53"	1000	49.461 €
T-9500	9500	224 - 300 336 - 450	32 x 2	5080	4 XPC	9642	380"	1300	51"	1346	53"	1000	53.556 €

F.R.S.: Frontal Reversible Shide Shift.

MODEL					N° BELTS TYPE								PRICE
	mm	KW-HP				A mm	A in	B mm	B in	C mm	C in		
F.R.S. T-3000	3000	224 - 300 336 - 450	28	1600	4 XPC	3237	127"	1470	58"	1242	49"	1000	19.455 €

Serrrat

IBP FRONTAL







GIROSTOP
SEKURLAST

CHARACTERISTICS

- ▶ Steel-plate chassis, thickness 6 mm.
- ▶ Tubular rotor of Ø 400 mm.
- ▶ Gearbox with freewheel included.
- ▶ 4 XPB side belt transmission.
- ▶ Forged hammers SERRAT special "grass".
- ▶ 2 lines of counter knives screwed.
- ▶ GIROSTOP system into the bolt of the hammer.
- ▶ Supports of bearing rotor in steel.
- ▶ High speed and high strength bearings.
- ▶ Rear height-adjustable roller Ø 180 mm.
- ▶ Double bearing on rear roller.
- ▶ Rear gum over the roller.
- ▶ Hydraulic front hood.
- ▶ PTO 540 rpm.
- ▶ Double bearing on rear roller.
- ▶ Model built under EC Normative.
- ▶ Safety indicators visible to personnel.

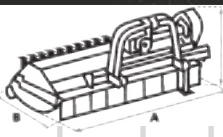

MODEL

MODEL					N° BELTS TYPE								PRICE
	mm	KW-HP		KG		A mm	A in	B mm	B in	C mm	C in		
T-1300	1300	22 - 30 60 - 80	9	370	4XPB	1495	59"	1155	45"	840	33"	540	6.784 €
T-1400	1400	30 - 40 60 - 80	12	397	4XPB	1595	63"	1155	45"	840	33"	540	7.040 €
T-1600	1600	37 - 50 60 - 80	12	420	4XPB	1795	71"	1155	45"	840	33"	540	7.424 €
T-1800	1800	45 - 60 60 - 80	16	456	4XPB	1995	79"	1155	45"	840	33"	540	7.808 €
T-2000	2000	52 - 70 60 - 80	16	480	4XPB	2195	79"	1155	45"	840	33"	540	8.320 €

ACCESSORIES

Hydraulic side shift	525 €	Configuration for radio-controlled Tool Carrier	4.096 €
Hooking	1.856 €		









CHARACTERISTICS

- ▶ Steel-plate chassis, thickness 10 mm.
- ▶ Rotor POLSER of Ø 450 mm.
- ▶ Gearbox SERRAT.
- ▶ 3 XPC side belt transmission.
- ▶ Forged agricultural hammers SERRAT.
- ▶ Two lines of steel counter hammers.
- ▶ GIROSTOP system into the bolt of the hammer.
- ▶ Supports of bearing rotor in steel.
- ▶ High speed and high strength bearings.
- ▶ Rear height-adjustable roller Ø 180/210 mm (from T-2000).
- ▶ Double bearing on rear roller.
- ▶ Rear gum over the roller.
- ▶ PTO 1.000 rpm.
- ▶ Hydraulic side shift.
- ▶ Hydraulic front hood.
- ▶ Long skid shoes.
- ▶ Model built under EC Normative.
- ▶ Safety indicators visible to personnel.

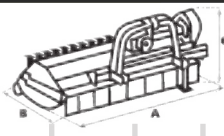

MODEL

MODEL					N° BELTS TYPE								PRICE
	mm	KW-HP		KG		A mm	A in	B mm	B in	C mm	C in		
T-1600	1600	45 - 60 90 - 120	12	720	3 XPC	1825	72"	1035	41"	995	39"	1.000	10.624 €
T-1800	1800	45 - 60 90 - 120	16	785	3 XPC	2025	80"	1035	41"	995	39"	1.000	11.135 €
T-2000	2000	45 - 60 90 - 120	16	875	3 XPC	2225	88"	1055	42"	995	39"	1.000	11.391 €
T-2300	2300	45 - 60 90 - 120	20	1050	3 XPC	2525	99"	1385	55"	1060	42"	1.000	11.904 €

ACCESSORIES

Freewheel	630 €
-----------	-------

serrat

INTERPIQUET







SEKURLAST



CHARACTERISTICS

- ▶ 3 point hitch - cat. II.
- ▶ Cutting width of 1.200 mm (47 inches).
- ▶ Backwardation from the axis of the tractor of 3.100 mm (122 inches).
- ▶ Length for the transport of 3.000 mm (118 inches).
- ▶ 3 retractable knives.
- ▶ Mechanical transmission by power take-off.
- ▶ Pushing control by hydropneumatic suspension (adjustable).
- ▶ Hydraulic recovery control (adjustable).
- ▶ Hydraulic location according to the necessity activated from the tractor (1 double effect's service).
- ▶ PTO 540 rpm.
- ▶ Rubber sleeve around the plate.
- ▶ Lower bowl of control on the ground.
- ▶ Height adjustable rear wheel.
- ▶ Model built under EC Normative.
- ▶ Safety indicators visible to personnel.



MODEL												PRICE
	mm	KW-HP		KG	A mm	A in	B mm	B in	C mm	C in		
INTERPIQUET	3100	30 - 40 74 - 100	3	450	3000	118"	3100	122"	1200	47"	540	7.808 €

ACCESSORIES







Protection for road	806 €
DIR: vertical wheel + protection	2.585 €



CHARACTERISTICS

- ▶ 3 point hitch - cat. II.
- ▶ Cutting width of 1.200 mm (47 inches).
- ▶ Backwardation from the axis of the tractor of 3.100 mm (122 inches).
- ▶ Length for the transport of 3.000 mm (118 inches).
- ▶ 24 tooth HighCut disc.
- ▶ Mechanical transmission by power take-off.
- ▶ Pushing control by hydropneumatic suspension (adjustable).
- ▶ Hydraulic recovery control (adjustable).
- ▶ Hydraulic location according to the necessity activated from the tractor (1 double effect's service).
- ▶ PTO 540 rpm.
- ▶ Rubber sleeve around the plate.
- ▶ Lower bowl of control on the ground.
- ▶ Height adjustable rear wheel.
- ▶ Model built under EC Normative.
- ▶ Safety indicators visible to personnel.



MODEL	   								 PRICE			
	mm	KW-HP		KG	A mm	A in	B mm	B in		C mm	C in	
INTERPIQUET	3100	51 - 70 78 - 105	24	540	3000	118"	3100	122"	1200	47"	540	11.263 €

serrat

INTERPIQUET DOBLE







SEKURLAST



CHARACTERISTICS

- ▶ 3 point hitch - cat. II.
- ▶ Cutting diameter of 1.200 mm.
- ▶ Cutting width of 6.200 mm - 6.500 mm.
- ▶ Length for the transport of 3.400 mm.
- ▶ 3 retractable knives in each plate.
- ▶ Air pressure adjustment (1 double effect's service).
- ▶ Pushing control by hydropneumatic suspension (adjustable).
- ▶ Lower bowl of control on the ground and rear wheels.
- ▶ Pushing control by hydro pneumatic suspension (2 hydraulics simple effect).
- ▶ PTO 540 rpm.
- ▶ Model built under EC Normative.
- ▶ Safety indicators visible to personnel.



MODEL												PRICE
	mm	KW-HP			A mm	A in	B mm	B in	C mm	C in		
T-6200	6200	51 - 70 78 - 105	3x2	1028	2536	100"	6200	244"	1200	47"	540	21.143 €
T-6500	6500	51 - 70 90 - 105	3x2	1032	2686	106"	6500	256"	1500	59"	540	22.551 €

ACCESSORIES







Double movable wheels for plate	1.138 €
---------------------------------	---------

CHARACTERISTICS

- ▶ Steel-plate chassis, thickness 8 mm.
- ▶ Tubular rotor of Ø 400 mm.
- ▶ Gearbox SERRAT.
- ▶ 3 XPC side belt transmission.
- ▶ Forged agricultural hammers SERRAT.
- ▶ Feeder with system BRALAKC.
- ▶ High torque hydraulic motor reversible.
- ▶ Supports of bearing rotor in steel.
- ▶ High speed and high strength bearings.
- ▶ PTO 540 rpm.
- ▶ Rear height-adjustable roller Ø 180 mm.
- ▶ Feed chain.
- ▶ GIROSTOP system into the bolt of the hammer.
- ▶ Double bearing on rear roller.
- ▶ Reversible toothed rear screen.
- ▶ Side plates.
- ▶ Model built under EC Normative.
- ▶ Safety indicators visible to personnel.

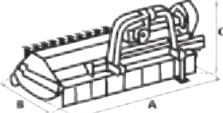

MODEL

MODEL	 mm	 KW-HP		 KG	N° BELTS TYPE								PRICE
						A mm	A in	B mm	B in	C mm	C in		
T-900	900	44 - 60 74 - 100	8	555	3 XPC	1100	43"	1195	47"	1031	41"	540	9.472 €
T-1250	1250	48 - 65 74 - 100	12	628	3 XPC	1445	57"	1195	47"	1098	43"	540	9.983 €
T-1400	1400	51 - 70 74 - 100	12	669	3 XPC	1595	63"	1195	47"	1098	43"	540	10.496 €
T-1500	1500	55 - 75 74 - 100	12	686	3 XPC	1700	67"	1195	47"	1098	43"	540	11.007 €
T-1800	1800	59 - 80 74 - 100	16	773	3 XPC	2000	79"	1195	47"	1098	43"	540	11.520 €
T-2000	2000	63 - 85 74 - 100	16	810	3 XPC	2200	87"	1195	47"	1098	43"	540	11.904 €

ACCESSORIES

Freewheel	630 €	Nylon windrower	295 €	Adjustable wheels kit	1.088 €
Pick-up tines	359 €	Fixed rear wheel kit	704 €		

Serrrat

OLI 450









CHARACTERISTICS

- ▶ Steel-plate chassis, thickness 10 mm.
- ▶ Tubular rotor of Ø 450 mm.
- ▶ Gearbox SERRAT.
- ▶ 3 XPC side belt transmission.
- ▶ Forged agricultural hammers SERRAT.
- ▶ Feeder with system BRALAKC.
- ▶ High torque hydraulic motor reversible.
- ▶ Supports of bearing rotor in steel.
- ▶ High speed and high strength bearings.
- ▶ PTO 1.000 rpm.
- ▶ Rear height-adjustable roller Ø 180 mm.
- ▶ Triple feed chain.
- ▶ GIROSTOP system into the bolt of the hammer.
- ▶ Double bearing on rear roller.
- ▶ Reversible toothed rear screen.
- ▶ Model built under EC Normative.
- ▶ Safety indicators visible to personnel.

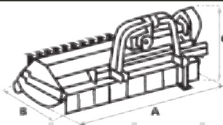

MODEL

MODEL					N° BELTS TYPE								PRICE
	mm	KW-HP		KG		A mm	A in	B mm	B in	C mm	C in		
T-1600	1600	45 - 60 88 - 120	12	1059	3 XPC	1815	71"	1245	49"	1215	48"	540	14.464 €
T-1800	1800	60 - 80 88 - 120	16	1147	3 XPC	2015	79"	1245	49"	1215	48"	1000	14.847 €
T-2000	2000	75 - 100 88 - 120	16	1222	3 XPC	2215	87"	1245	49"	1215	48"	1000	15.488 €

* Front or back lift to define at the order.

ACCESSORIES

Freewheel	630 €	Double hooking	1.191 €
Fixed rear wheel kit	973 €		

CHARACTERISTICS

- ▶ Steel-plate chassis, thickness 8 mm.
- ▶ Rotor with SPLINTER technology of Ø 350 mm.
- ▶ Gearbox SERRAT for tractors between 60 and 120 HP.
- ▶ 3 XPC side belt transmission.
- ▶ Treated blades.
- ▶ Feeder with system BRALAKC.
- ▶ High torque hydraulic motor reversible.
- ▶ Supports of bearing rotor in steel.
- ▶ High speed and high strength bearings.
- ▶ PTO 540 (110 HP).
- ▶ Triple feed chain.
- ▶ 3 lines of counter knives screwed.
- ▶ Ground-control rear fixed wheels.
- ▶ Model built under EC Normative.
- ▶ Safety indicators visible to personnel.



MODEL

MODEL					N° BELTS TYPE								PRICE
	mm	KW-HP		KG		A mm	A in	B mm	B in	C mm	C in		
T-1300	1300	45 - 60 88 - 120	37	850	3 XPC	1740	69"	1415	56"	1080	43"	540	14.921 €
T-1500	1500	52 - 70 88 - 120	43	960	3 XPC	1940	76"	1415	56"	1080	43"	540	16.107 €
T-1700	1700	60 - 80 88 - 120	48	1040	3 XPC	2140	84"	1415	56"	1080	43"	540	17.829 €

ACCESSORIES

Freewheel	630 €	Hidrahelp	4.557 €
Rear roller	336 €	Reversible	2.000 €



SPLINTER 450









CHARACTERISTICS

- ▶ Steel-plate chassis, thickness 10 mm.
- ▶ Rotor with SPLINTER technology of Ø 450 mm.
- ▶ Gearbox SERRAT for tractors between 70 and 140 HP.
- ▶ 3 XPC side belt transmission.
- ▶ Treated blades.
- ▶ Feeder with system BRALAKC.
- ▶ High torque hydraulic motor reversible.
- ▶ Supports of bearing rotor in steel.
- ▶ High speed and high strength bearings.
- ▶ PTO 540 (110 HP) or 1.000 rpm (140 HP).
- ▶ Triple feed chain.
- ▶ 3 lines of counter knives screwed.
- ▶ Ground-control rear fixed wheels.
- ▶ Model built under EC Normative.
- ▶ Safety indicators visible to personnel.

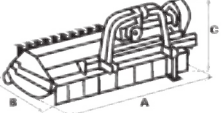

MODEL

MODEL	 mm	 KW-HP		 KG	N° BELTS TYPE								PRICE
						A mm	A in	B mm	B in	C mm	C in		
T-1600	1600	52 - 70 110 - 140	38	1108	3 XPC	1755	69"	1235	49"	1215	48"	540	18.432 €
T-1800	1800	60 - 80 110 - 140	42	1200	3 XPC	1955	77"	1235	49"	1215	48"	1000	20.223 €
T-2000	2000	67 - 90 110 - 140	48	1286	3 XPC	2155	85"	1235	49"	1215	48"	1000	21.120 €

ACCESSORIES







Freewheel	630 €	Hidrahelp	4.557 €
Rear roller	452 €	Reversible	2.000 €

CHARACTERISTICS

- ▶ Steel-plate chassis, thickness 8 mm.
- ▶ Rotor with SPLINTER technology of Ø 550 mm.
- ▶ Gearbox SERRAT for tractors between 90 and 180 HP.
- ▶ 4 XPC side belt transmission.
- ▶ Treated blades.
- ▶ Feeder with system BRALAKC.
- ▶ High torque hydraulic motor reversible.
- ▶ Supports of bearing rotor in steel.
- ▶ High speed and high strength bearings.
- ▶ PTO 1.000 rpm (170 HP).
- ▶ Double bearing on rear roller.
- ▶ Triple feed chain.
- ▶ 3 lines of counter knives screwed.
- ▶ Ground-control rear fixed wheels.
- ▶ Model built under EC Normative.
- ▶ Safety indicators visible to personnel.

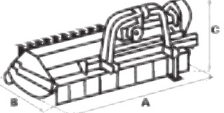

MODEL

MODEL	 mm	 KW-HP		 KG	N° BELTS TYPE								PRICE
						A mm	A in	B mm	B in	C mm	C in		
T-1800	1800	67 - 90 134 - 180	42	1570	4 XPC	2240	88"	1560	61"	1290	51"	1000	22.801 €
T-2000	2000	74 - 100 134 - 180	48	1800	4 XPC	2440	96"	1560	61"	1290	51"	1000	23.745 €
T-2300	2300	82 - 110 134 - 180	54	2000	4 XPC	2740	108"	1560	61"	1290	51"	1000	24.759 €

ACCESSORIES

Freewheel	630 €	Hidrahelp	4.557 €
Rear roller	452 €	Green	Consult

serrrat

KASTOR 350



SEKURLAST



CHARACTERISTICS

- ▶ Steel-plate chassis, thickness 8 mm.
- ▶ Rotor with system RHENDUEL of Ø 350 mm.
- ▶ Power of tractor between 60 - 90 HP.
- ▶ 3 XPC side belt transmission.
- ▶ Treated blades.
- ▶ Feeder with system BRALAKC.
- ▶ High torque hydraulic motor reversible.
- ▶ Supports of bearing rotor in steel.
- ▶ High speed and high strength bearings.
- ▶ PTO 540 rpm.
- ▶ Double bearing on rear roller.
- ▶ Triple feed chain.
- ▶ Double lines of counter hammers RHENDUEL.
- ▶ Model built under EC Normative.
- ▶ Safety indicators visible to personnel.



MODEL					N° BELTS TYPE								PRICE
						A mm	A in	B mm	B in	C mm	C in		
T-1500	1500	44 - 60 66 - 90	4 x 7	1020	3 XPC	1688	66"	1093	43"	1079	42"	540	16.639 €
T-1700	1700	59 - 80 66 - 90	4 x 8	1105	3 XPC	1888	74"	1093	43"	1079	42"	540	18.304 €

ACCESSORIES

Freewheel	630 €	Large knife	Free of charge
Double hooking	845 €		









CHARACTERISTICS

- ▶ Steel-plate chassis, thickness 10 mm.
- ▶ Rotor with system RHENDUEL of Ø 450 mm.
- ▶ Power of tractor between 60 - 120 HP.
- ▶ 3 XPC side belt transmission.
- ▶ Treated blades.
- ▶ Feeder with system BRALAKC.
- ▶ High torque hydraulic motor reversible.
- ▶ Supports of bearing rotor in steel.
- ▶ High speed and high strength bearings.
- ▶ PTO 540 rpm (1000 rpm from T-2000).
- ▶ Double bearing on rear roller.
- ▶ Triple feed chain.
- ▶ Double lines of counter hammers RHENDUEL.
- ▶ Model built under EC Normative.
- ▶ Safety indicators visible to personnel.



MODEL

MODEL					N° BELTS TYPE								PRICE
	mm	KW-HP				A mm	A in	B mm	B in	C mm	C in		
T-1600	1600	44 - 60 88 - 120	4 x 8	1356	3 XPC	1835	72"	1197	47"	1185	47"	540	18.943 €
T-1800	1800	60 - 80 88 - 120	4 x 9	1475	3 XPC	2037	80"	1197	47"	1185	47"	540	20.735 €
T-2000	2000	75 - 100 88 - 120	4 x 10	1590	3 XPC	2235	88"	1197	47"	1185	47"	1000	21.631 €

ACCESSORIES

Freewheel	630 €	Double hooking	1.191 €
-----------	-------	----------------	---------

KASTOR 550







SEKURLAST

CHARACTERISTICS

- ▶ Steel-plate chassis, thickness 10 mm.
- ▶ Rotor with system RHENDUEL of Ø 550 mm.
- ▶ Power of tractor between 100 - 160 HP.
- ▶ 4 XPC side belt transmission.
- ▶ Treated blades.
- ▶ Feeder with system BRALAKC.
- ▶ High torque hydraulic motor reversible.
- ▶ Supports of bearing rotor in steel.
- ▶ High speed and high strength bearings.
- ▶ PTO 1.000 rpm.
- ▶ Double bearing on rear roller.
- ▶ Triple feed chain.
- ▶ Double lines of counter hammers RHENDUEL.
- ▶ Model built under EC Normative.
- ▶ Safety indicators visible to personnel.

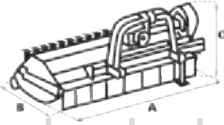

MODEL

MODEL	 mm	 KW-HP	 RHENDUEL	 KG	N° BELTS TYPE								PRICE
						A mm	A in	B mm	B in	C mm	C in		
T-1600	1600	74 - 100 119 - 160	6 x 8	1720	4 XPC	1865	73"	1845	73"	1000	39"	1000	22.272 €
T-1800	1800	81 - 110 119 - 160	6 x 9	1858	4 XPC	2065	81"	1845	73"	1000	39"	1000	23.295 €
T-2000	2000	88 - 120 119 - 160	6 x 10	1993	4 XPC	2265	90"	1845	73"	1000	39"	1000	24.703 €
T-2300	2300	96 - 130 119 - 160	6 x 11	2193	4 XPC	2565	101"	1845	73"	1000	39"	1000	26.751 €

ACCESSORIES

Freewheel

630 €



CHARACTERISTICS

- ▶ Steel-plate chassis, thickness 15 mm.
- ▶ Rotor with system RHENDUEL of Ø 625 mm.
- ▶ Power of tractor between 220 - 350 HP.
- ▶ 2 x 5 XPC side belt transmission.
- ▶ Treated blades.
- ▶ Feeder with system BRALAKC.
- ▶ High torque hydraulic motor reversible.
- ▶ Supports of bearing rotor in steel.
- ▶ High speed and high strength bearings.
- ▶ PTO 1.000 rpm.
- ▶ Ground-control skid shoes.
- ▶ Double pick-up with triple feed chain.
- ▶ Three lines of counter hammers RHENDUEL.
- ▶ 3 point hitch category III.
- ▶ Model built under EC Normative.
- ▶ Safety indicators visible to personnel.



MODEL					N° BELTS TYPE								PRICE
	mm	KW-HP				A mm	A in	B mm	B in	C mm	C in		
T-2250	2250	164 - 220 261 - 350	6 x 9	4220	2 x 5 XPC	2735	108"	1890	74"	1600	63"	1000	57.213 €

ACCESSORIES	
Centralized greasing	2.368 €





Forestry Range









CHARACTERISTICS

- ▶ Steel-plate chassis, thickness 8 mm.
- ▶ Rotor POLSER + of Ø 470 mm.
- ▶ Gearbox SERRAT.
- ▶ 3 XPC side belt transmission.
- ▶ Swinging 360° forged forestry hammers SERRAT or fixed tooth with tip in tungsten or blades DRR.
- ▶ Supports of bearing rotor in steel.
- ▶ Oscillating bearings of double row of rollers.
- ▶ Front protection curtain.
- ▶ PTO 540 rpm.
- ▶ System antiwire in rotor.
- ▶ Steel counter hammers.

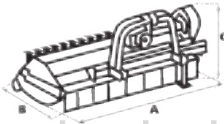

- ▶ Front skid shoes.
- ▶ Rear hydraulic hood.
- ▶ Model built under EC Normative.
- ▶ Safety indicators visible to personnel.

MODEL

MODEL							N° BELTS TYPE							
	mm	KW-HP				KG		A mm	A in	B mm	B in	C mm	C in	
T-1400	1400	37 - 50 82 - 110	12	36	18	789	3 XPC	1640	65"	1070	42"	970	38"	540
T-1600	1600	44 - 60 82 - 110	16	44	22	862	3 XPC	1840	72"	1070	42"	970	38"	540
T-1800	1800	52 - 70 82 - 110	16	46	24	924	3 XPC	2040	80"	1070	42"	970	38"	540
T-2000	2000	60 - 80 82 - 110	20	50	26	966	4 XPC	2240	88"	1070	42"	970	38"	540

MODEL	PRICE	PRICE	PRICE	MODEL	PRICE	PRICE	PRICE
	HAMMER	FIXED TOOTH	DRR		HAMMER	FIXED TOOTH	DRR
T-1400	10.240 €	12.800 €	12.800 €	T-1800	13.184 €	16.383 €	16.383 €
T-1600	11.904 €	14.592 €	14.592 €	T-2000	14.464 €	17.663 €	17.663 €

ACCESSORIES

OPTION









Freewheel	630 €	Hydraulic side shift	730 €	750 rpm PTO	Free of charge
Mechanic pushing frame	717 €	Compact drive cover	448 €	1.000 rpm PTO	Free of charge



CHARACTERISTICS

- ▶ Steel-plate chassis, thickness 10 mm.
- ▶ Rotor POLSER + of Ø 550 mm.
- ▶ Gearbox SERRAT for 150 HP.
- ▶ 3/4 XPC side belt transmission.
- ▶ Swinging 360° forged forestry hammers SERRAT or fixed tooth with tip in tungsten or blades DRR.
- ▶ Supports of bearing rotor in steel.
- ▶ Oscillating bearings of double row of rollers.
- ▶ Front protection curtain.
- ▶ PTO 540 rpm (1000 rpm from T-1800).
- ▶ System antiwire in rotor.
- ▶ Steel counter hammers.
- ▶ Front skid shoes.
- ▶ Third hydraulic point.
- ▶ Model built under EC Normative.
- ▶ Safety indicators visible to personnel.

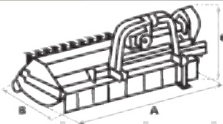
MODEL

MODEL							N° BELTS TYPE							
	mm	KW-HP				KG		A mm	A in	B mm	B in	C mm	C in	
T-1400	1400	60 - 80 112 - 150	12	36	18	1040	3 XPC	1680	66"	1340	53"	1010	40"	540
T-1600	1600	65 - 88 112 - 150	12	40	22	1160	3 XPC	1880	74"	1340	53"	1010	40"	540
T-1800	1800	74 - 100 112 - 150	16	45	22	1253	4 XPC	2080	82"	1340	53"	1010	40"	1000
T-2000	2000	82 - 110 112 - 150	16	50	24	1325	4 XPC	2280	90"	1340	53"	1010	40"	1000
T-2300	2300	96 - 130 112 - 150	20	58	28	1510	4 XPC	2580	102"	1340	53"	1010	40"	1000

MODEL	PRICE	PRICE	PRICE	MODEL	PRICE	PRICE	PRICE
	HAMMER	FIXED TOOTH	DRR		HAMMER	FIXED TOOTH	DRR
T-1400	13.695 €	15.872 €	15.872 €	T-2000	16.255 €	19.712 €	19.712 €
T-1600	14.208 €	16.639 €	16.639 €	T-2300	18.815 €	22.527 €	22.527 €
T-1800	15.231 €	18.304 €	18.304 €				









ACCESSORIES

Freewheel	630 €	Hydraulic pushing frame	2.521 €	Preparation for front lift (gearbox)	1.344 €
Reinforced rotor (by metre)	1.651 €	Hydraulic side shift	1.946 €	Hidrahelp	4.557 €
Mechanic pushing frame	1.600 €	Hydraulic rear hood	2.445 €	Compact drive cover	448 €

CHARACTERISTICS

- ▶ Steel-plate chassis, thickness 10 mm.
- ▶ Rotor POLSER + of Ø 550 mm.
- ▶ Gearbox with freewheel included.
- ▶ 2 x 3 XPC side belt transmission.
- ▶ Swinging 360° forged forestry hammers SERRAT or fixed tooth with tip in tungsten or blades DRR.
- ▶ Supports of bearing rotor in steel.
- ▶ Oscillating bearings of double row of rollers.
- ▶ Front protection curtain.
- ▶ PTO 1.000 rpm.
- ▶ Steel counter hammers.
- ▶ Front skid shoes.
- ▶ Rear hydraulic hood.
- ▶ System antiwire in rotor.
- ▶ Compact drive cover.
- ▶ Hydraulic pushing frame.
- ▶ Reinforced teeth of the pushing frame.
- ▶ Model built under EC Normative.
- ▶ Safety indicators visible to personnel.

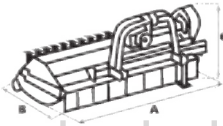

MODEL							N° BELTS TYPE							
	mm	KW-HP				KG		A mm	A in	B mm	B in	C mm	C in	
T-2000	2000	112 - 150 172 - 230	16	50	26	1990	2 x 3 XPC	2345	92"	1840	72"	1380	54"	1000
T-2300	2300	119 - 160 172 - 230	20	58	30	2200	2 x 3 XPC	2645	104"	1840	72"	1380	54"	1000
T-2500	2500	134 - 180 172 - 230	20	62	32	2290	2 x 3 XPC	2845	112"	1840	72"	1380	54"	1000

MODEL	PRICE HAMMER	PRICE FIXED TOOTH	PRICE DRR
T-2000	27.647 €	30.463 €	30.463 €
T-2300	30.206 €	33.663 €	33.663 €
T-2500	32.255 €	35.967 €	35.967 €

ACCESSORIES	
Torque converter	11.430 €
Hidrahelpe	4.557 €
Centralized greasing	2.560 €

CHARACTERISTICS

- ▶ Steel-plate chassis, thickness 10 mm.
- ▶ Rotor POLSER + of Ø 625 mm.
- ▶ Gearbox with freewheel included.
- ▶ 2 x 4 XPC side belt transmission.
- ▶ Swinging 360° forged forestry hammers SERRAT or fixed tooth with tip in tungsten or blades DRR.
- ▶ Supports of bearing rotor in steel.
- ▶ Oscillating bearings of double row of rollers.
- ▶ Double front safety chains.
- ▶ PTO 1.000 rpm.
- ▶ Steel counter hammers.
- ▶ Front skid shoes.
- ▶ Rear hydraulic hood.
- ▶ Chassis internal reinforcements.
- ▶ System antiwire in rotor.
- ▶ Compact drive cover.
- ▶ Hydraulic pushing frame.
- ▶ Transmission by cardan to side belts.
- ▶ Pulleys of diameter 290 mm.
- ▶ Model built under EC Normative.
- ▶ Safety indicators visible to personnel.



MODEL

							N° BELTS TYPE		
	mm	KW-HP				KG		A mm A in B mm B in C mm C in	
T-2000	2000	134 - 180 208 - 280	20	50	26	2830	2 x 4 XPC	2370 94" 1940 76" 1730 68" 1000	
T-2300	2300	134 - 180 208 - 280	20	58	28	3220	2 x 4 XPC	2670 106" 1940 76" 1730 68" 1000	
T-2500	2500	134 - 180 208 - 280	25	62	30	3450	2 x 4 XPC	2870 114" 1940 76" 1730 68" 1000	

PRICE

MODEL	PRICE HAMMER	PRICE FIXED TOOTH	PRICE DRR
T-2000	41.726 €	44.926 €	44.926 €
T-2300	44.414 €	47.871 €	47.871 €
T-2500	46.719 €	50.814 €	50.814 €

ACCESSORIES

Torque converter	23.564 €
Hidrahelp	4.557 €
Rail Box	2.304 €
Centralized greasing	2.560 €

CHARACTERISTICS

- ▶ Steel-plate chassis, thickness 12 mm.
- ▶ Rotor POLSER + of Ø 725 mm.
- ▶ Gearbox with freewheel included.
- ▶ 2 x 5 XPC side belt transmission.
- ▶ Swinging 360° forged forestry hammers SERRAT or fixed tooth with tip in tungsten or blades DRR.
- ▶ Supports of bearing rotor in steel.
- ▶ Oscillating bearings of double row of rollers.
- ▶ Double front safety chains.
- ▶ PTO 1.000 rpm.
- ▶ Steel counter hammers.
- ▶ Front skid shoes.
- ▶ Rear hydraulic hood.
- ▶ Hydraulic pushing frame.
- ▶ System antiwire in rotor.
- ▶ Compact drive cover.



- ▶ Chassis internal reinforcements.
- ▶ Transmission by cardan to side belts.
- ▶ Pulleys of diameter 350 mm.
- ▶ Model built under EC Normative.
- ▶ Safety indicators visible to personnel.







MODEL							N° BELTS TYPE							
	mm	KW-HP				KG		A mm	A in	B mm	B in	C mm	C in	
T-2000	2000	149 - 200 261 - 350	36	48	24	4000	2 x 5 XPC	2500	98"	2090	82"	1930	76"	1000
T-2300	2300	149 - 200 261 - 350	48	58	28	4350	2 x 5 XPC	2800	110"	2090	82"	1930	76"	1000
T-2500	2500	149 - 200 261 - 350	48	66	42	4830	2 x 5 XPC	3000	118"	2090	82"	1930	76"	1000

MODEL	PRICE	PRICE	PRICE	ACCESSORIES			
	HAMMER	FIXED TOOTH	DRR				
T-2000	54.654 €	58.110 €	58.110 €	Torque converter	23.564 €	Hidrahelp	4.557 €
T-2300	58.238 €	62.078 €	62.078 €	Third hydraulic point	1.127 €	Rail Box	2.304 €
T-2500	59.390 €	64.126 €	64.126 €	Centralized greasing	2.560 €		

CHARACTERISTICS

- ▶ Steel-plate chassis, thickness 15 mm.
- ▶ Rotor POLSER + of Ø 1.100 mm.
- ▶ Gearbox with freewheel included.
- ▶ Synchronous belts transmission.
- ▶ Fixed tooth with tip in tungsten or blades DRR.
- ▶ Gearbox with Synkrodos-600.
- ▶ Supports of bearing rotor in steel.
- ▶ Oscillating bearings of double row of rollers.
- ▶ Triple front safety chains.
- ▶ PTO 1.000 rpm.
- ▶ Steel counter hammers.
- ▶ Front skid shoes.
- ▶ Rear hydraulic hood with line of steel counter hammers.
- ▶ Hydraulic pushing frame.
- ▶ Centralized greasing.
- ▶ System antiwire in rotor.
- ▶ Compact drive cover.
- ▶ Chassis internal reinforcements.
- ▶ Transmission by cardan to side belts.
- ▶ Pulleys of diameter 450 mm.
- ▶ Model built under EC Normative.
- ▶ Safety indicators visible to personnel.

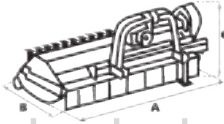

MODEL						N° BELTS TYPE							
							A mm	A in	B mm	B in	C mm	C in	
T-2600	2600	223 - 300 447 - 600	128	64	7050	Synchronous	2705	107"	2270	89"	1700	67"	1000

MODEL	PRICE	PRICE
	FIXED TOOTH	DRR
T-2600	119.420 €	119.420 €





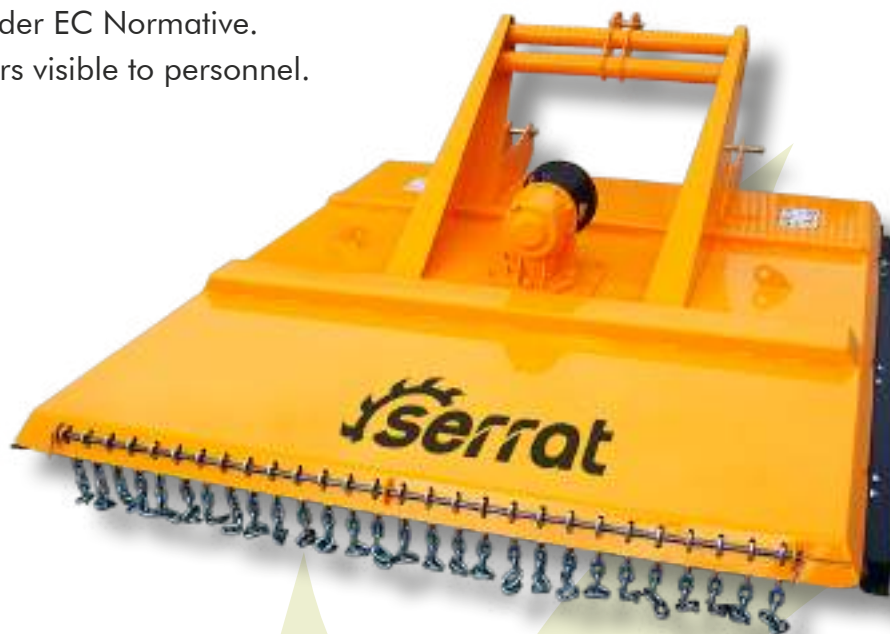

ACCESSORIES	
Torque converter	30.206 €
Hidrahelp	4.557 €
Rail Box	2.304 €

CHARACTERISTICS

- ▶ Steel-plate closed chassis 5 mm.
- ▶ PTO 540 rpm.
- ▶ SERRAT rotor with 2 chains with links of Ø 13 mm.
- ▶ Front protection curtain.
- ▶ Height-adjustable skid shoes.
- ▶ Direct transmission.
- ▶ Model built under EC Normative.
- ▶ Safety indicators visible to personnel.

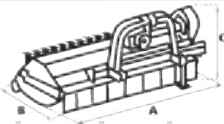

MODEL

MODEL												PRICE	
	mm	KW-HP	Ø	Ud.	A mm	A in	B mm	B in	C mm	C in			
T-1500	1500	37 - 50 60 - 80	13	2	360	1678	66"	1910	75"	880	35"	540	4.607 €
T-1800	1800	44 - 60 60 - 80	13	2	437	1978	78"	2271	90"	880	35"	540	5.248 €
T-2000	2000	51 - 70 60 - 80	13	2	472	2178	86"	2423	95"	880	35"	540	5.760 €







ACCESSORIES

Clutch in the transmission	499 €
----------------------------	-------

CHARACTERISTICS

- ▶ Steel-plate closed chassis, thickness of 10mm + 5 mm.
- ▶ PTO 540 rpm.
- ▶ SERRAT rotor with 4 chains with links of Ø 16 mm.
- ▶ Front protection curtain.
- ▶ Lower reinforcements (links of chains).
- ▶ Top reinforcements.
- ▶ Height-adjustable skid shoes.
- ▶ Transmission with freewheel.
- ▶ High-power gearbox.
- ▶ Model built under EC Normative.
- ▶ Safety indicators visible to personnel.

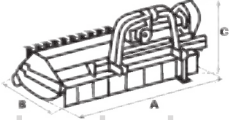

MODEL												PRICE	
	mm	KW-HP	Ø	Ud.	KG	A mm	A in	B mm	B in	C mm	C in		
T-1400	1400	45 - 60 75 - 100	16	4	600	1757	69"	1860	73"	1186	47"	540	7.167 €
T-1600	1600	60 - 80 88 - 120	16	4	650	1957	77"	2050	81"	1186	47"	540	7.424 €
T-1800	1800	74 - 100 88 - 120	16	4	800	2160	85"	2200	87"	1186	47"	540	8.064 €
T-2000	2000	81 - 110 88 - 120	16	4	1120	2357	93"	2303	91"	1186	47"	540	8.575 €









CHARACTERISTICS

- ▶ Steel-plate closed or open chassis, thickness 15 mm + 10 mm.
- ▶ PTO 1.000 rpm.
- ▶ SERRAT rotor with 4 chains with links of Ø 16 mm.
- ▶ Front protection curtain.
- ▶ Lower reinforcements (links of chains).
- ▶ Top reinforcements.
- ▶ Height-adjustable skid shoes.
- ▶ Transmission with freewheel.
- ▶ High-power gearbox.
- ▶ Model built under EC Normative.
- ▶ Safety indicators visible to personnel.

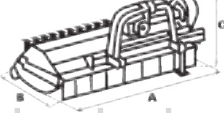

MODEL

												PRICE	
	mm	KW-HP	Ø		Ud.	A mm	A in	B mm	B in	C mm			C in
T-1400	1400	60 - 80 119 - 160	16	4	1031	1757	69"	1860	73"	1615	64"	1000	7.808 €
T-1600	1600	67 - 90 119 - 160	16	4	1184	1957	77"	2050	81"	1615	64"	1000	8.960 €
T-1800	1800	75 - 100 119 - 160	16	4	1318	2160	85"	2200	87"	1615	64"	1000	9.855 €
T-2000	2000	82 - 110 119 - 160	16	4	1435	2357	93"	2305	91"	1615	64"	1000	10.496 €

ACCESSORIES

Rear hydraulic hood

2.368 €

Chains of Ø 19 mm

Free of charge



Soil Range



FIXE TOP



CHARACTERISTICS

- ▶ Steel-plate chassis, thickness 8 mm.
- ▶ Rotor FIXE TOP of Ø 470 mm.
- ▶ Gearbox with freewheel included.
- ▶ Double synchronous belt transmission.
- ▶ Supports of bearing rotor in steel.
- ▶ Oscillating bearings of double row of rollers.
- ▶ Double ploughshare for opening the land.
- ▶ PTO 1.000 rpm.
- ▶ Rear hydraulic hood.
- ▶ Chassis internal reinforcements.
- ▶ System antiwire in rotor.
- ▶ Compact drive cover.
- ▶ Transmission by cardan to side belts.
- ▶ Centralized greasing.
- ▶ Hydraulic levelling roller.
- ▶ Model built under EC Normative.
- ▶ Safety indicators visible to personnel.



MODEL

MODEL					N° BELTS TYPE								PRICE
	mm	KW-HP				A mm	A in	B mm	B in	C mm	C in		
T-1600	1600	75 - 100 112 - 150	32	1665	2 Synchronous	1615	64"	1500	59"	1430	56"	1000	39.039 €
T-1800	1800	88 - 120 112 - 150	38	1780	2 Synchronous	1815	70"	1500	59"	1430	56"	1000	41.726 €
T-2000	2000	97 - 130 112 - 150	44	1900	2 Synchronous	2015	79"	1500	59"	1430	56"	1000	44.286 €
T-2300	2300	104 - 140 112 - 150	52	2200	2 Synchronous	2315	91"	1500	59"	1430	56"	1000	46.846 €

ACCESSORIES

Third hydraulic point

2.688 €



FIXE TOP

SEKURLAST



CHARACTERISTICS

- ▶ Steel-plate chassis, thickness 10 mm.
- ▶ Rotor FIXE TOP of Ø 550 mm.
- ▶ Gearbox with freewheel included.
- ▶ Double synchronous belt transmission.
- ▶ Supports of bearing rotor in steel.
- ▶ Oscillating bearings of double row of rollers.
- ▶ Double ploughshare for opening the land.
- ▶ PTO 1.000 rpm.
- ▶ Rear hydraulic hood.
- ▶ Chassis internal reinforcements.
- ▶ System antiwire in rotor.
- ▶ Compact drive cover.
- ▶ Transmission by cardan to side belts.
- ▶ Centralized greasing.
- ▶ Hydraulic levelling roller.
- ▶ Model built under EC Normative.
- ▶ Safety indicators visible to personnel.



Soil

MODEL					N° BELTS TYPE								PRICE
	mm	KW-HP				A mm	A in	B mm	B in	C mm	C in		
T-2000	2000	112 - 150 149 - 200	36	2880	2 Synchronous	2080	81"	1500	60"	1670	66"	1000	61.438 €
T-2300	2300	127 - 170 186 - 250	48	3220	2 Synchronous	2380	94"	1500	60"	1670	66"	1000	65.406 €
T-2700	2700	149 - 200 186 - 250	60	3580	2 Synchronous	2780	109"	1500	60"	1670	66"	1000	68.350 €

ACCESSORIES

Third hydraulic point

2.688 €



FIXE TOP



CHARACTERISTICS

- ▶ Steel-plate chassis, thickness 12 mm.
- ▶ Rotor FIXE TOP of Ø 625 mm.
- ▶ Gearbox with freewheel included.
- ▶ Double synchronous belt transmission.
- ▶ Supports of bearing rotor in steel.
- ▶ Oscillating bearings of double row of rollers.
- ▶ Double ploughshare for opening the land.
- ▶ PTO 1.000 rpm.
- ▶ Rear hydraulic hood.
- ▶ Chassis internal reinforcements.
- ▶ System antiwire in rotor.
- ▶ Compact drive cover.
- ▶ Transmission by cardan to side belts.
- ▶ Centralized greasing.
- ▶ Hydraulic levelling roller.
- ▶ Model built under EC Normative.
- ▶ Safety indicators visible to personnel.



MODEL

MODEL					N° BELTS TYPE								PRICE
	mm	KW-HP		KG		A mm	A in	B mm	B in	C mm	C in		
T-2500	2500	186 - 250 224 - 500	55	4100	2 Synchronous	2500	98"	1740	69"	1870	74"	1000	101.628 €
T-3000	3000	186 - 250 298 - 500	62	4700	2 Synchronous	3000	118"	1740	69"	1870	74"	1000	107.003 €

ACCESSORIES

Third hydraulic point







3.354 €

CHARACTERISTICS

- ▶ Steel-plate chassis, thickness 20 mm.
- ▶ Solid rotor Harland Ø 625 mm.
- ▶ Gearbox Synkrodos.
- ▶ Double synchronous belt transmission.
- ▶ Direct transmission with Synchrochain belts.
- ▶ Supports of bearing rotor in steel.
- ▶ Oscillating bearings of double row of rollers.
- ▶ Double plow for opening the ground with screwed anti-wear.
- ▶ Heavy tooth with tungsten inserts.
- ▶ PTO 1.000 rpm.
- ▶ Rear hydraulic hood.
- ▶ Bolted internal chassis reinforcements.
- ▶ Replaceable wear rings on the rotor.
- ▶ Compact drive cover.
- ▶ Centralized greasing.
- ▶ Model built under EC Normative.

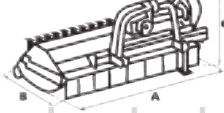

MODEL

MODEL					N° BELTS TYPE								PRICE
	mm	KW-HP		KG		A mm	A in	B mm	B in	C mm	C in		
T-2600	2600	224 - 300 447 - 600	10	6250	2 Synchronous	2600	102"	1740	69"	1870	74"	1000	112.298 €
T-3000	3000	224 - 300 447 - 600	12	7150	2 Synchronous	3000	118"	1740	69"	1870	74"	1000	129.203 €



FIXE TOP

SEKURLAST



CHARACTERISTICS

- ▶ Steel-plate chassis, thickness 8 mm.
- ▶ Rotor FIXE TOP of Ø 470 mm.
- ▶ Gearbox SERRAT for 120 HP.
- ▶ 4 XPC belt transmission.
- ▶ Supports of bearing rotor in steel.
- ▶ Oscillating bearings of double row of rollers.
- ▶ PTO 540 rpm.
- ▶ Rear hydraulic hood.
- ▶ Chassis internal reinforcements.
- ▶ System antiwire in rotor.
- ▶ Compact drive cover.
- ▶ Raer roller into the hood.
- ▶ Model built under EC Normative.
- ▶ Safety indicators visible to personnel.



MODEL

MODEL	mm	KW-HP		KG	N° BELTS TYPE								PRICE
						A mm	A in	B mm	B in	C mm	C in		
T-1200	1200	59 - 80 75 - 100	30	870	4 XPC	1420	56"	1415	60"	950	66"	540	18.333 €
T-1400	1400	59 - 80 75 - 100	36	1015	4 XPC	1620	64"	1415	60"	950	66"	540	20.685 €
T-1600	1600	59 - 80 75 - 100	42	1160	4 XPC	1820	72"	1415	60"	950	66"	540	23.468 €
T-1800	1800	59 - 80 88 - 120	48	1300	4 XPC	2020	80"	1415	60"	950	66"	540	26.093 €
T-2000	2000	59 - 80 88 - 120	50	1450	4 XPC	2220	87"	1415	60"	950	66"	540	27.615 €

ACCESSORIES

Centralized greasing

2.560 €



FIXE TOP

SEKURLAST



CHARACTERISTICS

- ▶ Steel-plate chassis, thickness 10 mm.
- ▶ Rotor FIXE TOP of Ø 550 mm.
- ▶ Gearbox SERRAT for 150 HP.
- ▶ 5 XPC belt transmission.
- ▶ Supports of bearing rotor in steel.
- ▶ Oscillating bearings of double row of rollers.
- ▶ PTO 540 rpm.
- ▶ Rear hydraulic hood.
- ▶ Chassis internal reinforcements.
- ▶ System antiwire in rotor.
- ▶ Compact drive cover.
- ▶ Raer roller into the hood.
- ▶ Model built under EC Normative.
- ▶ Safety indicators visible to personnel.



Soil

MODEL					N° BELTS TYPE								PRICE
	mm	KW-HP				A mm	A in	B mm	B in	C mm	C in		
T-1600	1600	74 - 100 97 - 130	40	1260	5 XPC	1880	74"	1340	53"	1010	40"	540	30.324 €
T-1800	1800	74 - 100 97 - 130	45	1353	5 XPC	2080	82"	1340	53"	1010	40"	540	32.655 €
T-2000	2000	74 - 100 112 - 150	50	1425	5 XPC	2280	90"	1340	53"	1010	40"	540	35.175 €

ACCESSORIES

Centralized greasing

2.560 €



FIXE TOP



CHARACTERISTICS

- ▶ Steel-plate chassis, thickness 10 mm.
- ▶ Rotor FIXE TOP of Ø 550 mm.
- ▶ Centralising greasing system
- ▶ Gearbox SERRAT for 220 HP.
- ▶ 2 x 4 XPC belt transmission.
- ▶ Supports of bearing rotor in steel.
- ▶ Oscillating bearings of double row of rollers.
- ▶ PTO 1.000 rpm.
- ▶ Rear hydraulic hood.
- ▶ Chassis internal reinforcements.
- ▶ System antiwire in rotor.
- ▶ Compact drive cover.
- ▶ Hydraulic levelling roller.
- ▶ Model built under EC Normative.
- ▶ Safety indicators visible to personnel.



MODEL



N° BELTS
TYPE

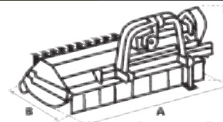

PRICE

MODEL	mm	KW-HP		KG	N° BELTS TYPE	A mm	A in	B mm	B in	C mm	C in		PRICE
T-2000	2000	104 - 150 164 - 220	50	1990	2x4 XPC	2345	92"	1840	72"	1380	54"	1000	46.043 €
T-2300	2300	104 - 150 164 - 220	58	2200	2x4 XPC	2645	104"	1840	72"	1380	54"	1000	48.615 €
T-2500	2500	104 - 150 164 - 220	62	2290	2x4 XPC	2845	112"	1840	72"	1380	54"	1000	51.240 €



FIXE TOP









CHARACTERISTICS

- ▶ Steel-plate chassis, thickness 12 mm.
- ▶ Rotor FIXE TOP of Ø 700 mm.
- ▶ Centralising greasing system
- ▶ Gearbox SERRAT for 600 HP with Synkrodos-600.
- ▶ Double synchronous belt transmission.
- ▶ Supports of bearing rotor in steel.
- ▶ Oscillating bearings of double row of rollers.
- ▶ PTO 1.000 rpm.
- ▶ Rear hydraulic hood.
- ▶ Chassis internal reinforcements.
- ▶ Anvil interchangeable.
- ▶ System antiwire in rotor.
- ▶ Compact drive cover.
- ▶ Hydraulic levelling roller.
- ▶ Model built under EC Normative.
- ▶ Safety indicators visible to personnel.

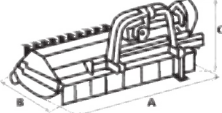

Soil

MODEL







MODEL					N° BELTS TYPE								PRICE
	mm	KW-HP				A mm	A in	B mm	B in	C mm	C in		
T-2500	2500	223 -300 447 -600	58	5000	2 Synchronous	2890	114"	2400	94"	1610	63"	1000	97.020 €

CHARACTERISTICS

- ▶ Steel-plate chassis, thickness 12 mm.
- ▶ Gearbox SERRAT 350 HP
- ▶ Double synchronous belt transmission.
- ▶ Supports of bearing rotor in steel.
- ▶ Oscillating bearings of double row of rollers.
- ▶ Interchangeable rotor shaft.
- ▶ Solid steel rotor with teeth fitted inside the rotor.
- ▶ Double ploughshare for opening the land.
- ▶ PTO 1.000 rpm.
- ▶ Front skid shoes.
- ▶ Rear hydraulic hood.
- ▶ Interchangeable 8 mm welded plates Hardox internal reinforcement.
- ▶ System antiwire in rotor.
- ▶ Compact drive cover.
- ▶ Model built under EC Normative.
- ▶ Safety indicators visible to personnel.

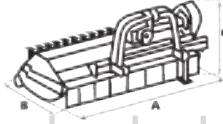

MODEL

MODEL					N° BELTS TYPE								PRICE
	mm	KW-HP		KG		A mm	A in	B mm	B in	C mm	C in		
T-1100	1100	149 - 200 257 - 350	48	3600	2 Synchronous	1100	43"	1954	77"	1500	59"	1000	73.500 €

ACCESSORIES

Centralized greasing

2.560 €









CHARACTERISTICS

- ▶ Directional device of hooking CAT II and III.
- ▶ System of supply by replaceable anti-wear steel knives.
- ▶ Loading by hydraulic feed belt.
- ▶ 4 XPC side belt transmission.
- ▶ System of grinding with steel hammers.
- ▶ PTO 1.000 rpm.
- ▶ Chamber of grinding lined in sheet URSSA 500.
- ▶ Model built under EC Normative.
- ▶ Safety indicators visible to personnel.
- ▶ Approved for driving on the road as a trailer.

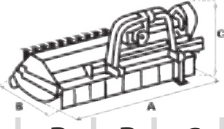

Soil

MODEL					N° BELTS TYPE								PRICE
	mm	KW-HP				A mm	A in	B mm	B in	C mm	C in		
T-1800	1800	59 - 80 88 - 120	16	2876	4 XPC	2404	95"	3827	151"	1589	63"	1000	61.950 €

OPTION

Centralized greasing	2.560 €	Magnets	9.369 €
----------------------	---------	---------	---------





Hydraulic heads

Hydraulic Heads



GIROSTOP

SEKURLAST



CHARACTERISTICS

- ▶ Non-wear steel-plate chassis, thickness 4 mm.
- ▶ Tubular rotor with grass flails or forged agricultural hammers SERRAT.
- ▶ Head for mini excavators of weight until 3,5 T.
- ▶ Synchronous belts transmission.
- ▶ Double safety chains.
- ▶ High speed and high strength bearings.
- ▶ Hydraulic gear motor.
- ▶ Valve of recirculation incorporated into the motor.
- ▶ Front skid shoes.
- ▶ Model built under EC Normative.
- ▶ Safety indicators visible to personnel.



MODEL	mm	HORSE POWER				KG	N° BELTS TYPE							RPM Rotor max.	PRICE
		min. req.	max. aut.					A mm	A in	B mm	B in	C mm	C in		
T-800	800	35-45 l/min	200 bar	16x2	9	140	Synchronous	910	36"	640	25"	487	19"	3000	4.992 €

ACCESSORIES

Rear roller	448 €	Hooking	269 €
-------------	-------	---------	-------



CHARACTERISTICS

- ▶ Non-wear steel-plate chassis, thickness 6 mm.
- ▶ Rotor POLSER of Ø 470 mm.
- ▶ Mulcher for excavators having a weight between 3,5 and 6 T.
- ▶ 3 XPB side belt transmission.
- ▶ Double safety chains.
- ▶ High speed and high strength bearings.
- ▶ Hydraulic gear motor.
- ▶ Valve of recirculation incorporated into the motor.
- ▶ Front skid shoes.
- ▶ Model built under EC Normative.
- ▶ Safety indicators visible to personnel.



MODEL	mm	HORSE POWER				KG	N° BELTS TYPE							RPM Rotor max.	PRICE
		min. req.	max. aut.					A mm	A in	B mm	B in	C mm	C in		
T-600	600	50-80 l/min	180 bar	24	9	262	3 XPB	735	26"	875	34"	645	25"	2500	6.461 €
T-800	800	50-80 l/min	180 bar	32	9	298	3 XPB	935	37"	875	34"	645	25"	2500	6.705 €
T-1000	1000	50-80 l/min	180 bar	40	12	336	3 XPB	1135	45"	875	34"	645	25"	2500	7.192 €
T-1200	1200	50-80 l/min	180 bar	48	12	373	3 XPB	1335	53"	875	34"	645	25"	2500	7.680 €







ACCESSORIES

Ripper	832 €	Hooking	589 €	Price fixed tooth (by metre)	2.625 €
Rear roller	448 €	Hydraulic engine with pistons	1.561 €		

CHARACTERISTICS

- ▶ Non-wear steel-plate chassis, thickness 8 mm.
- ▶ Rotor POLSER + of Ø 470 mm.
- ▶ Mulcher for excavators having a weight between 6 and 15 T.
- ▶ 3 XPC side belt transmission.
- ▶ Double safety chains.
- ▶ High speed and high strength bearings.
- ▶ Hydraulic engine with pistons.
- ▶ Valve of recirculation incorporated into the motor.
- ▶ Front skid shoes.
- ▶ Compact drive cover.
- ▶ Swinging forged forestry hammers 360° or fixed tooth with tip in tungsten or blades DRR.
- ▶ Model built under EC Normative.
- ▶ Safety indicators visible to personnel.

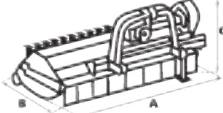







MODEL	 mm	HORSE POWER						N° BELTS TYPE							 RPM Rotor max.
		min. req.	max. aut.						A mm	A in	B mm	B in	C mm	C in	
T-800	800	70-90 l/min	350 bar	8	20	10	618	3 XPC	1075	42"	1145	45"	720	28"	2200
T-1000	1000	70-90 l/min	350 bar	8	26	13	695	3 XPC	1275	50"	1145	45"	720	28"	2200
T-1200	1200	70-90 l/min	350 bar	12	32	15	771	3 XPC	1475	58"	1145	45"	720	28"	2200
T-1400	1400	70-90 l/min	350 bar	12	36	18	839	3 XPC	1675	66"	1145	45"	720	28"	2200

MODEL	PRICE			ACCESSORIES			
	HAMMER	FIXED TOOTH	DRR				
T-800	11.391 €	12.800 €	12.800 €	Hooking	883 €	Variable displacement motor	9.600 €
T-1000	11.904 €	13.440 €	13.440 €	Rear roller	448 €	Ripper	973 €
T-1200	12.160 €	14.208 €	14.208 €	Mechanical hood	1.037 €	Ripper with integrated hooking	1.856 €
T-1400	12.671 €	14.975 €	14.975 €	Hydraulic hood	2.227 €		

CHARACTERISTICS

- ▶ Non-wear steel-plate chassis, thickness 10 mm.
- ▶ Rotor POLSER + of Ø 550 mm.
- ▶ Mulcher for excavators having a weight between 15 and 30 T.
- ▶ 4 XPC side belt transmission.
- ▶ Double safety chains.
- ▶ High speed and high strength bearings.
- ▶ Hydraulic engine with pistons.
- ▶ Valve of recirculation incorporated into the motor.
- ▶ Front skid shoes.
- ▶ Compact drive cover.
- ▶ Swinging forged forestry hammers 360° or fixed tooth with tip in tungsten or blades DRR.
- ▶ Model built under EC Normative.
- ▶ Safety indicators visible to personnel.

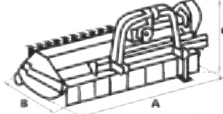

MODEL	 mm	HORSE POWER					 KG	N° BELTS TYPE							 RPM Rotor max.
		min. req.	max. aut.						A mm	A in	B mm	B in	C mm	C in	
T-1000	1000	150-160 l/min	350 bar	9	26	14	900	4 XPC	1280	50"	1150	45"	803	32"	2000
T-1250	1250	150-160 l/min	350 bar	9	32	16	1024	4 XPC	1530	60"	1150	45"	810	32"	2000
T-1500	1500	150-160 l/min	350 bar	12	38	20	1172	4 XPC	1780	70"	1150	45"	810	32"	2000
T-1600	1600	150-160 l/min	350 bar	12	40	22	1229	4 XPC	1880	74"	1150	45"	810	32"	2000
T-1800	1800	150-160 l/min	350 bar	16	44	24	1325	4 XPC	2080	82"	1150	45"	810	32"	2000
T-2000	2000	150-160 l/min	350 bar	16	50	26	1428	4 XPC	2280	90"	1150	45"	810	32"	2000

MODEL	PRICE	PRICE	PRICE	MODEL	PRICE	PRICE	PRICE
	HAMMER	FIXED TOOTH	DRR		HAMMER	FIXED TOOTH	DRR
T-1000	15.616 €	17.535 €	17.535 €	T-1600	19.967 €	22.911 €	22.911 €
T-1250	18.176 €	20.607 €	20.607 €	T-1800	20.735 €	23.935 €	23.935 €
T-1500	18.943 €	21.631 €	21.631 €	T-2000	25.343 €	28.799 €	28.799 €

ACCESSORIES





Hooking	1.241 €	Pikes HIGH CUT per unit	114 €	Variable displacement motor	9.600 €
Mechanical front hood	1.037 €	Ripper with integrated hooking	2.738 €	Hydraulic rotanting	8.589 €
Hydraulic front hood	2.227 €	Ripper	1.497 €		

CHARACTERISTICS

- ▶ Non-wear steel-plate chassis, thickness 10 mm.
- ▶ Rotor POLSER + of Ø 625 mm.
- ▶ Mulcher for excavators having a weight between 25 and 50 T.
- ▶ 5 XPC side belt transmission.
- ▶ Double safety chains.
- ▶ Swinging forged forestry hammers 360° or fixed tooth with tip in tungsten or blades DRR.
- ▶ High speed and high strength bearings.
- ▶ Hydraulic engine with pistons.
- ▶ Valve of recirculation incorporated into the motor.
- ▶ Front skid shoes.
- ▶ Model built under EC Normative.
- ▶ Safety indicators visible to personnel.

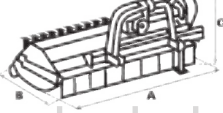

MODEL	PRICE	PRICE	PRICE
	HAMMER	FIXED TOOTH	DRR
T-2000	31.486 €	34.559 €	34.559 €
T-2300	33.151 €	36.990 €	36.990 €

MODEL	 mm	 HORSE POWER					 KG	N° BELTS TYPE							 RPM Rotor max.
		min. req.	max. aut.						A mm	A in	B mm	B in	C mm	C in	
T-2000	2000	200-220 l/min	350 bar	20	50	26	1820	5 XPC	2278	90"	1316	52"	912	36"	1800
T-2300	2300	200-220 l/min	350 bar	20	56	30	2250	5 XPC	2580	102"	1316	52"	912	36"	1800







ACCESSORIES

Hooking	1.241 €	Mechanical hood	1.037 €	Variable displacement motor	9.600 €
Ripper with integrated hooking	4.263 €	Hydraulic hood	3.200 €	Hydraulic rotanting	8.589 €
Centralized greasing	2.560 €				

CHARACTERISTICS

- ▶ Non-wear steel-plate chassis, thickness 6 mm.
- ▶ Tubular rotor with grass flails or forged agricultural hammers SERRAT.
- ▶ Mulcher for head compact track loader having a weight until 5 T.
- ▶ 3 XPB side belt transmission.
- ▶ Safety chains.
- ▶ High speed and high strength bearings.
- ▶ Hydraulic gear motor.
- ▶ Valve of recirculation incorporated into the motor.
- ▶ Front skid shoes.
- ▶ Model built under EC Normative.
- ▶ Safety indicators visible to personnel.

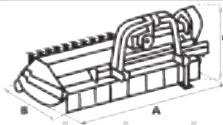

MODEL	 mm	HORSE POWER				 KG	N° BELTS TYPE							 RPM Rotor max.	PRICE
		min. req.	max. aut.					A mm	A in	B mm	B in	C mm	C in		
T-1400	1400	70-80 l/min	180 bar	40	12	560	3 XPB	1610	63"	940	37"	726	29"	2500	9.983 €
T-1600	1600	70-80 l/min	180 bar	48	16	600	3 XPB	1810	71"	940	37"	726	29"	2500	10.368 €
T-1800	1800	70-80 l/min	180 bar	48	16	638	3 XPB	2010	79"	940	37"	726	29"	2500	10.880 €







ACCESSORIES

Hooking	1.856 €	Hydraulic engine with pistons	1.561 €
Hydraulic hood	2.227 €	Price fixed tooth (by metre)	2.625 €
Hydraulic side shift	3.982 €		

CHARACTERISTICS

- ▶ Non-wear steel-plate chassis, thickness 8 mm.
- ▶ Rotor POLSER + of Ø 470 mm.
- ▶ Mulcher for head compact track loader having a weight between 3 and 9 T.
- ▶ 3 CX side belt transmission.
- ▶ Safety chains.
- ▶ High speed and high strength bearings.
- ▶ Hydraulic engine with pistons.
- ▶ Front skid shoes.
- ▶ Swinging forged forestry hammers 360° or fixed tooth with tip in tungsten or blades DRR.
- ▶ Compact drive cover.
- ▶ Valve of recirculation incorporated into the motor.
- ▶ Rear hydraulic hood.
- ▶ Model built under EC Normative.
- ▶ Safety indicators visible to personnel.

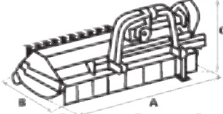

MODEL	 mm	HORSE POWER					 KG	N° BELTS TYPE						 RPM Rotor max.	
		min. req.	max. aut.						A mm	A in	B mm	B in	C mm		C in
T-1400	1400	90-100 l/min	350 bar	12	36	18	793	3 CX	1635	64"	995	39"	812	32"	2200
T-1600	1600	90-100 l/min	350 bar	16	44	22	897	3 CX	1835	72"	995	39"	812	32"	2200
T-1800	1800	90-100 l/min	350 bar	16	50	24	957	3 CX	2035	80"	995	39"	812	32"	2200
T-2000	2000	90-100 l/min	350 bar	20	50	26	1015	3 CX	2235	88"	995	39"	812	32"	2200

MODEL	PRICE	PRICE	PRICE
	HAMMER	FIXED TOOTH	DRR
T-1400	12.287 €	15.231 €	15.231 €
T-1600	13.440 €	16.127 €	16.127 €
T-1800	14.464 €	17.407 €	17.407 €
T-2000	15.872 €	18.943 €	18.943 €

ACCESSORIES	
Hooking	1.856 €
Hydraulic pushing frame	1.664 €
Fixed pushing frame	717 €
Hydraulic side shift	3.982 €

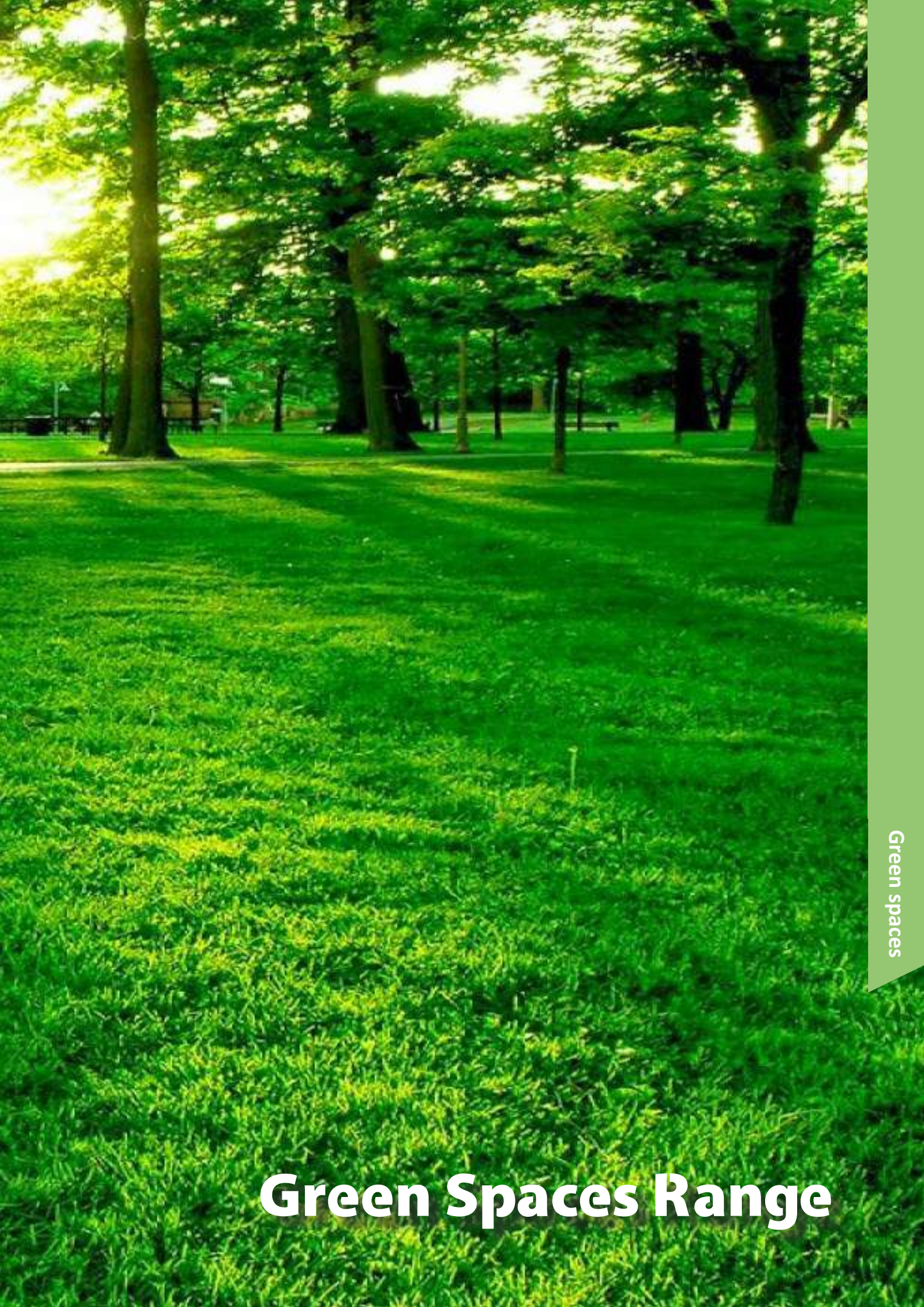

Green Spaces Range





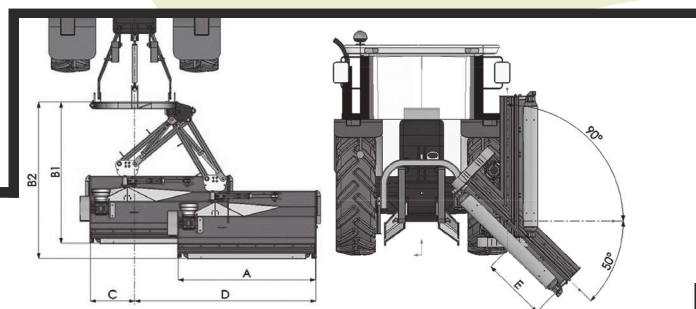

CHARACTERISTICS

- ▶ Non-wear steel-plate chassis.
- ▶ Rotor tubular of Ø 400 mm.
- ▶ Angulation +90° / -50°.
- ▶ 3 XPB side belt transmission.
- ▶ GIROSTOP system into the bolt of the hammer.
- ▶ Stamped hammers SERRAT.
- ▶ Height-adjustable rear roller Ø 180 mm.
- ▶ PTO 540 rpm.
- ▶ Gearbox with freewheel included.
- ▶ Front protection curtain.
- ▶ Hydraulic lateral offset mulcher.
- ▶ Front skid shoes.
- ▶ Model built under EC Normative.
- ▶ Safety indicators visible to personnel.



MODEL

					N° BELTS TYPE	A	B1	B2	C	D	E	
	mm	KW-HP				mm-in	mm-in	mm-in	mm-in	mm-in	mm-in	
T-1400	1400	26 - 35 59 - 80	12	445	3 XPB	1599 - 63"	1645 - 65"	1820 - 72"	510 - 20"	1650 - 65"	535 - 21"	540
T-1600	1600	34 - 45 59 - 80	16	470	3 XPB	1799 - 71"	1645 - 65"	1820 - 72"	510 - 20"	1850 - 73"	735 - 29"	540
T-1800	1800	37 - 50 59 - 80	16	500	3 XPB	1999 - 79"	1645 - 65"	1820 - 72"	510 - 20"	2050 - 81"	935 - 37"	540

MODEL

PRICE

T-1400	9.088 €
T-1600	9.472 €
T-1800	9.983 €

ACCESSORIES

Homocinetic knot

819 €

CHARACTERISTICS

- ▶ Non-wear steel-plate chassis, thickness 8 mm.
- ▶ Rotor POLSER of Ø 450 mm.
- ▶ Gearbox SERRAT until 120 HP.
- ▶ 3 XPC side belt transmission.
- ▶ GIROSTOP system into the bolt of the hammer.
- ▶ Hammers guaranteed against breakage.
- ▶ Height-adjustable rear roller Ø 180 mm.
- ▶ PTO 750 rpm.
- ▶ High speed and high strength bearings.
- ▶ Front protection curtain.
- ▶ Front skid shoes.
- ▶ Double bearing on rear roller.
- ▶ Angulation +90°/-50°.
- ▶ Hydraulic lateral offset mulcher.
- ▶ Supports of bearing rotor in steel.
- ▶ Rear gum.
- ▶ 3 point hitch - cat. 2 and 3.
- ▶ Safety valve.
- ▶ Model built under EC Normative.
- ▶ Safety indicators visible to personnel.

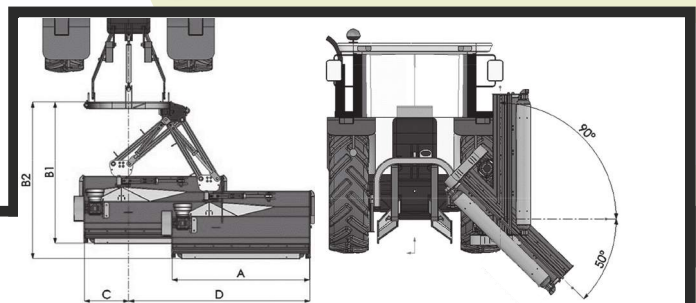







MODEL



N° BELTS
TYPE

A mm-in **B1** mm-in **B2** mm-in **C** mm-in **D** mm-in  **PRICE**

MODEL	mm	KW-HP						N° BELTS TYPE	A mm-in	B1 mm-in	B2 mm-in	C mm-in	D mm-in		PRICE
T-1600	1600	51 - 70 88 - 120	12	24	885	3 XPC		1884 - 74"	1975 - 78"	2290 - 90"	345 - 14"	1750 - 69"	750	12.160 €	
T-1800	1800	59 - 80 88 - 120	16	28	920	3 XPC		2058 - 81"	1975 - 78"	2290 - 90"	345 - 14"	2950 - 116"	750	12.415 €	
T-2000	2000	59 - 80 88 - 120	16	32	955	3 XPC		2258 - 89"	1975 - 78"	2290 - 90"	345 - 14"	3150 - 124"	750	13.312 €	
T-2300	2300	66 - 90 88 - 120	20	40	1015	3 XPC		2558 - 101"	1975 - 78"	2290 - 90"	345 - 14"	3450 - 136"	750	13.823 €	

*With external gearbox:

- T-1600: A=2118 mm - 83"
- T-1800: A=2292 mm - 90"
- T-2000: A=2492 mm - 98"
- T-2300: A=2779 mm - 109"





ACCESSORIES

Homocinetic knot	819 €	Internal gearbox	Free of charge
Compact drive cover	384 €	Rotor FX3	7.424 €

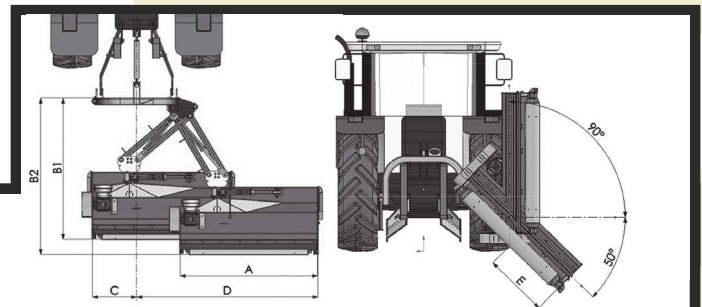
CHARACTERISTICS

- ▶ Non-wear steel-plate chassis, thickness 10 mm.
- ▶ Rotor POLSER of Ø 550 mm.
- ▶ External gearbox SERRAT.
- ▶ 4 XPC side belt transmission.
- ▶ Supports of bearing rotor in steel.
- ▶ Height-adjustable rear roller Ø 210 mm.
- ▶ PTO 750 rpm.
- ▶ High speed and high strength bearings.
- ▶ Front protection curtain.
- ▶ Front skid shoes.
- ▶ Double bearing on rear roller.
- ▶ Angulation +90° / -50°.
- ▶ Hydraulic lateral offset mulcher.
- ▶ Safety valve.
- ▶ Model built under EC Normative.
- ▶ Safety indicators visible to personnel.



MODEL					N° BELTS TYPE	A	B1	B2	C	D	E	
	mm	KW-HP				mm-in	mm-in	mm-in	mm-in	mm-in	mm-in	
T-1800	1800	89 - 120 127 - 170	16	1655	4 XPC	1800- 71"	2494 - 98"	3091 - 122"	436 - 17"	2927 - 115"	1220 -48"	750
T-2000	2000	97 - 130 127 - 170	16	1710	4 XPC	2000- 79"	2494 - 98"	3091 - 122"	436 - 17"	3127 - 123"	1420 -56"	750
T-2300	2300	104 - 140 134 - 180	20	1790	4 XPC	2300- 91"	2494 - 98"	3091 - 122"	436 - 17"	3427- 135"	1720 -68"	750
T-2500	2500	112 - 150 134 - 180	20	1835	4 XPC	2500- 98"	2494 - 98"	3091 - 122"	436 - 17"	3627 - 143"	1920 -76"	750





MODEL	PRICE	MODEL	PRICE
T-1800	21.183 €	T-2300	22.208 €
T-2000	21.567 €	T-2500	22.975 €

ACCESSORIES	
Internal gearbox	Free of charge

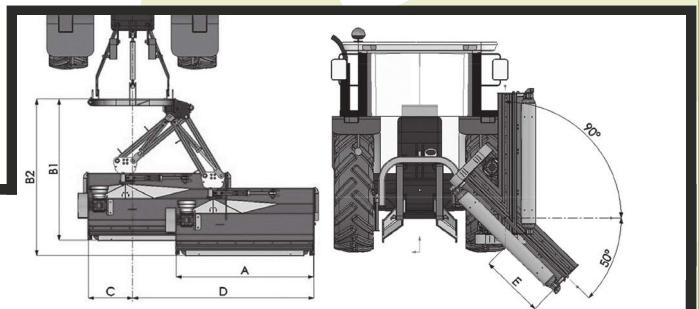
CHARACTERISTICS

- ▶ Non-wear steel-plate chassis, thickness 10 mm.
- ▶ Rotor POLSER+ of Ø 550 mm.
- ▶ Gearbox SERRAT.
- ▶ 4 XPC side belt transmission.
- ▶ Double transmission with a centre shaft and homocinetic knot on the second transmission.
- ▶ Supports of bearing rotor in steel.
- ▶ Height-adjustable rear roller Ø 210 mm.
- ▶ PTO 750 rpm.
- ▶ High speed and high strength bearings.
- ▶ Front protection curtain.
- ▶ Front skid shoes.
- ▶ Double bearing on rear roller.
- ▶ Angulation +90°/-50°.
- ▶ Hydraulic lateral offset mulcher.
- ▶ Safety valve.
- ▶ Model built under EC Normative.
- ▶ Safety indicators visible to personnel.



MODEL					N° BELTS TYPE	A	B1	B2	C	D	E	
	mm	KW-HP		KG		mm-in	mm-in	mm-in	mm-in	mm-in	mm-in	
T-1600	1600	104 - 140 149 - 200	12	1600	4 XPC	1600 - 63"	2981 - 117"	3004 - 118"	608 - 24"	2335 - 92"	439 - 17"	750
T-1800	1800	104 - 140 149 - 200	16	1800	4 XPC	1800 - 71"	2981 - 117"	3004 - 118"	608 - 24"	2535 - 100"	639 - 25"	750
T-2000	2000	104 - 140 149 - 200	16	2050	4 XPC	2000 - 79"	2981 - 117"	3004 - 118"	608 - 24"	2735 - 108"	839 - 33"	750
T-2300	2300	104 - 140 149 - 200	20	2300	4 XPC	2300 - 91"	2981 - 117"	3004 - 118"	608 - 24"	3035 - 119"	1139 - 45"	750
T-2500	2500	104 - 140 149 - 200	24	2400	4 XPC	2500 - 98"	2981 - 117"	3004 - 118"	608 - 24"	3235 - 128"	1339 - 53"	750

MODEL	PRICE	MODEL	PRICE	MODEL	PRICE
T-1600	24.831 €	T-2000	26.367 €	T-2500	29.823 €
T-1800	25.471 €	T-2300	27.391 €		

ACCESSORIES	
Internal gearbox	Free of charge











Biomass Range



CHARACTERISTICS

- ▶ Non-wear steel-plate chassis, thickness 6 mm.
- ▶ Hammers guaranteed against breakage.
- ▶ Tubular rotor of Ø 400 mm.
- ▶ Side belt transmission.
- ▶ GIROSTOP system into the bolt of the hammer.
- ▶ Basket of storage.
- ▶ Hydraulic unload.
- ▶ PTO 540 rpm.
- ▶ Short skid shoes.
- ▶ Height-adjustable rear roller.
- ▶ Model built under EC Normative.
- ▶ Safety indicators visible to personnel.

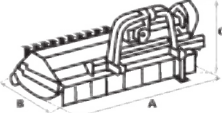

MODEL	  		CAPACITY HOPPER		N° BELTS TYPE								PRICE	
	mm	KW-HP				A mm	A in	B mm	B in	C mm	C in			
T-1400	1400	29 - 40 59 - 80	12	0,79 m ³	620	3 XPC	1650	65"	1650	65"	1180	46"	540	9.600 €
T-1600	1600	37 - 50 59 - 80	12	0,91 m ³	665	3 XPC	1850	73"	1650	65"	1180	46"	540	9.855 €
T-1800	1800	44 - 60 59 - 80	16	1,00 m ³	720	3 XPC	2050	81"	1650	65"	1180	46"	540	10.368 €
T-2000	2000	48 - 65 59 - 80	16	1,14 m ³	770	3 XPC	2250	89"	1650	65"	1180	46"	540	10.624 €







ACCESSORIES

Freewheel	630 €	Front adjustable long skid shoes	423 €
-----------	-------	----------------------------------	-------

CHARACTERISTICS

- ▶ Non-wear steel-plate chassis, thickness 8 mm.
- ▶ Rotor POLSER of Ø 550 mm.
- ▶ Hammers guaranteed against breakage.
- ▶ Side belt transmission.
- ▶ GIROSTOP system into the bolt of the hammer.
- ▶ Basket of storage.
- ▶ Hydraulic unload.
- ▶ PTO 540 rpm.
- ▶ Short skid shoes.
- ▶ Height-adjustable rear roller.
- ▶ Model built under EC Normative.
- ▶ Safety indicators visible to personnel.

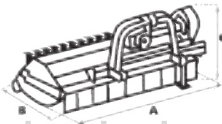

MODEL				CAPACITY HOPPER		N° BELTS TYPE								PRICE
	mm	KW-HP					A mm	A in	B mm	B in	C mm	C in		
T-1800	1800	63 - 85 96 - 130	16	2,3 m ³	1170	3 XPC	2060	81"	2179	86"	1558	61"	540	11.904 €
T-2000	2000	63 - 85 96 - 130	16	2,5 m ³	1255	3 XPC	2260	89"	2179	86"	1558	61"	540	13.823 €

ACCESSORIES

Freewheel	630 €	Front chains (by metre)	167 €
Front adjustable long skid shoes	423 €		

CHARACTERISTICS

- ▶ 3 point hitch category II.
- ▶ Non-wear steel-plate chassis, thickness 8 mm.
- ▶ Double hydraulic feeder, system BRALAKC.
- ▶ 3+4 XPC / XPB side belt transmission.
- ▶ Rotor with system RHENDUEL of Ø 350 mm.
- ▶ Triple feed chain.
- ▶ Reaction and impulse turbine with independent transmission.
- ▶ Start system HIDRAHELP.
- ▶ PTO 1.000 rpm.
- ▶ Rear height-adjustable roller Ø 180 mm.
- ▶ Cardan transmission with mechanical protection.
- ▶ It includes 6 meters of tube.
- ▶ Model built under EC Normative.
- ▶ Safety indicators visible to personnel.



MODEL					N° BELTS TYPE								PRICE
	mm	KW-HP				A mm	A in	B mm	B in	C mm	C in		
T-1500	1500	59 - 80 88 - 120	4 x 7	1358	3 + 4 XPC/XPB	1860	63"	1255	49"	1180	46"	1000	42.751 €
T-1700	1700	59 - 80 88 - 120	4 x 8	1459	3 + 4 XPC/XPB	2060	81"	1255	49"	1180	46"	1000	45.822 €
T-2000	2000	61 - 80 88 - 120	4 x 10	1616	3 + 4 XPC/XPB	2360	93"	1255	49"	1180	46"	1000	48.766 €

ACCESSORIES

Anti-blocking system	4.173 €	Discharge chute	1.856 €
----------------------	---------	-----------------	---------



CHARACTERISTICS

- ▶ 3 point hitch category II-III.
- ▶ Non-wear steel-plate chassis, thickness 8 mm.
- ▶ Double hydraulic feeder, system BRALAKC.
- ▶ 4+4 XPC / XPB side belt transmission.
- ▶ Rotor with system RHENDUEL of Ø 450 mm.
- ▶ Triple feed chain.
- ▶ Reaction and impulse turbine with independent transmission.
- ▶ Start system HIDRAHELP.
- ▶ PTO 1.000 rpm.
- ▶ Rear height-adjustable roller Ø 210 mm.
- ▶ Cardan transmission with mechanical protection.
- ▶ It includes 6 meters of tube.
- ▶ Model built under EC Normative.
- ▶ Safety indicators visible to personnel.



MODEL					N° BELTS TYPE								PRICE
	mm	KW-HP				A mm	A in	B mm	B in	C mm	C in		
T-2000	2000	112 - 150 134 - 180	4 x 10	2135	4 + 4 XPC/XPB	2480	98"	1345	53"	1390	55"	1000	56.446 €

ACCESSORIES			
Anti-blocking system	4.173 €	Hydraulic inclinable discharge chute (+ adjustable)	3.865 €
Trailer hooking	410 €		

serrat

BIOMASS 200



SEKURLAST



CHARACTERISTICS

- ▶ 3 point hitch category II-III.
- ▶ Non-wear steel-plate chassis, thickness 10 mm.
- ▶ Double hydraulic feeder, system BRALAKC.
- ▶ 4+3 XPC side belt transmission.
- ▶ Rotor with system RHENDUEL of Ø 550 mm.
- ▶ Triple feed chain.
- ▶ Reaction and impulse turbine with independant transmission.
- ▶ Start system HIDRAHELP.
- ▶ PTO 1.000 rpm.
- ▶ Front skid shoes.
- ▶ Cardan transmission with mechanical protection.
- ▶ It includes 6 meters of tube.
- ▶ Model built under EC Normative.
- ▶ Safety indicators visible to personnel.



MODEL	mm		KW-HP	RHENDUEL	KG	Nº BELTS TYPE							PRICE	
	A	A					B	B	C	C				
	mm	in	mm	in	mm	in	mm	in	mm	in				
T-2000	2000	98"	112 - 150 186 - 250	6 x 10	2498	4 + 3 XPC	2490	98"	1435	56"	1420	56"	1000	64.126 €
T-2300	2300	110"	112 - 150 186 - 250	6 x 11	2736	4 + 3 XPC	2790	110"	1435	56"	1420	56"	1000	67.198 €

ACCESSORIES

Anti-blocking system	4.173 €	Hydraulic inclinable discharge chute (+ adjustable)	3.865 €
Discharge chute	1.856 €		



BIOMASS 400







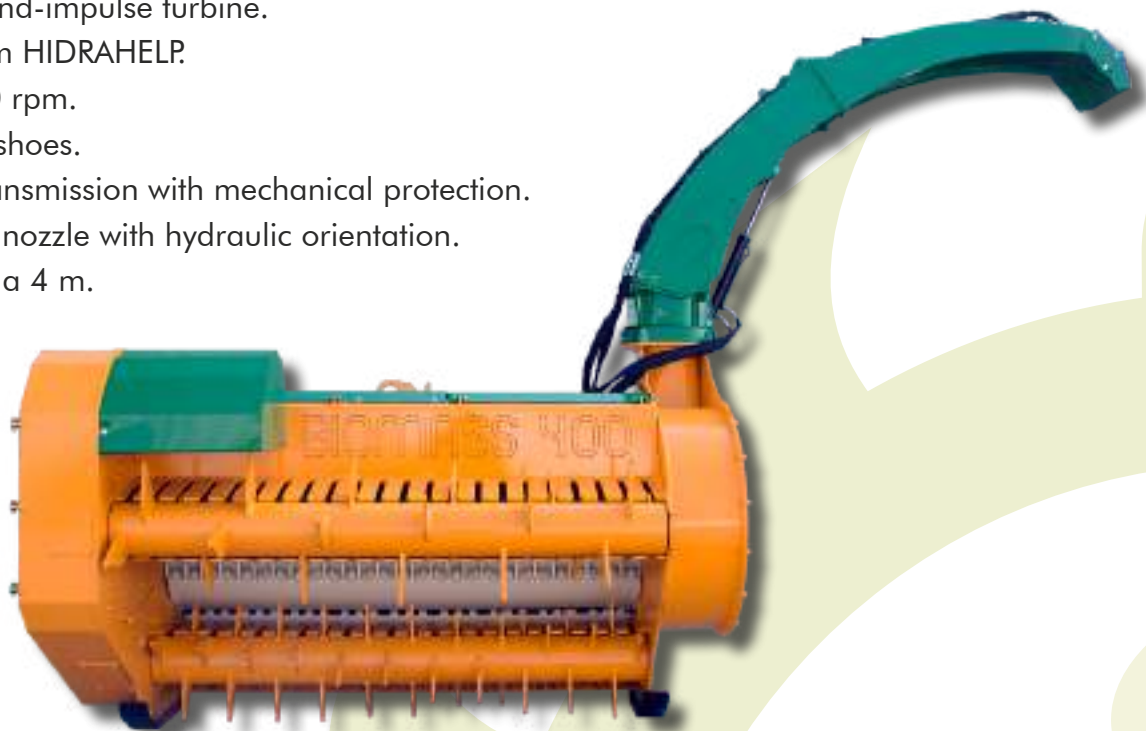

CHARACTERISTICS

- ▶ 3 point hitch category IV.
 - ▶ Non-wear steel-plate chassis, thickness 12 mm.
 - ▶ Double hydraulic feeder, system BRALAKC.
 - ▶ Synchronous belts transmission.
 - ▶ Rotor with system SPLINTER Ø 625 mm.
 - ▶ Triple feed chain.
 - ▶ Reaction-and-impulse turbine.
 - ▶ Start system HIDRAHELP.
 - ▶ PTO 1.000 rpm.
 - ▶ Front skid shoes.
 - ▶ Cardan transmission with mechanical protection.
 - ▶ Launching nozzle with hydraulic orientation.
- Download a 4 m.

- ▶ Model built under EC Normative.
- ▶ Safety indicators visible to personnel.

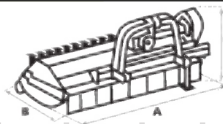







MODEL	 mm	 KW-HP		 KG	Nº BELTS TYPE								PRICE
						A mm	A in	B mm	B in	C mm	C in		
T-2250	2250	220 - 300 368 - 500	9 x 4	5795	Synchronous	3130	123"	2160	85"	2545	100"	1000	147.194 €

ACCESSORIES	
Anti-blocking system	4.173 €

CHARACTERISTICS

- ▶ Non-wear steel-plate chassis, thickness 8 mm.
- ▶ Rotor POLSER of Ø 600 mm.
- ▶ Gearbox SERRAT.
- ▶ 5 XPC side belt transmission.
- ▶ GIROSTOP system into the bolt of the hammer.
- ▶ Steel counter hammers.
- ▶ Reaction and impulse turbine with independent transmission.
- ▶ PTO 1.000 rpm.
- ▶ High speed and high strength bearings.
- ▶ Front protection curtain.
- ▶ Obturations antiwire in rotor.
- ▶ Steel worm screw Ø 300 mm.
- ▶ Supports of bearing rotor in steel.
- ▶ Forged hammers SERRAT special "grass".
- ▶ Model built under EC Normative.
- ▶ Safety indicators visible to personnel.

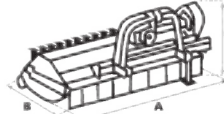

MODEL	 mm	 KW-HP		 KG	N° BELTS TYPE								PRICE
						A mm	A in	B mm	B in	C mm	C in		
T-2000	2000	88 - 120 134 - 180	16	1505	5 XPC	2460	97"	1150	45"	950	37"	1000	50.814 €
T-2300	2300	88 - 120 134 - 180	20	1700	5 XPC	2760	109"	1150	45"	950	37"	1000	53.758 €







ACCESSORIES

Hydraulic side shift	1.561 €	Second high pressure turbine for the rear power lift	10.777 €
Rear roller	1.856 €	Side compensator	1.305 €
Freewheel	630 €	Trailer hooking	730 €

CHARACTERISTICS

- ▶ Non-wear steel-plate chassis, thickness 10 mm.
- ▶ Rotor POLSER+ of Ø 600 mm.
- ▶ Gearbox SERRAT for tractors of 180 HP.
- ▶ 5 XPC side belt transmission.
- ▶ Forged forestry hammers SERRAT.
- ▶ Steel counter hammers.
- ▶ Reaction and impulse turbine with independent transmission.
- ▶ PTO 1.000 rpm.
- ▶ High speed and high strength bearings.
- ▶ Obturations antiwire in rotor.
- ▶ Front protection curtain.
- ▶ Steel worm screw Ø 300 mm.
- ▶ Supports of bearing rotor in steel.
- ▶ Model built under EC Normative.
- ▶ Safety indicators visible to personnel.

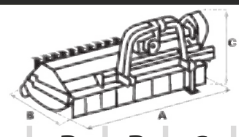

MODEL					N° BELTS TYPE								PRICE
	mm	KW-HP		KG		A mm	A in	B mm	B in	C mm	C in		
T-2000	2000	134 - 180 164 - 220	32	2050	5 XPC	2460	97"	1150	45"	950	37"	1000	85.244 €
T-2300	2300	134 - 180 164 - 220	40	2300	5 XPC	2760	109"	1150	45"	950	37"	1000	88.317 €

ACCESSORIES





Hydraulic side shift	1.561 €	Second high pressure turbine for the rear power lift	10.777 €
Rear roller	1.856 €	Side compensator	1.305 €



CHARACTERISTICS

- ▶ 3 point hitch category II.
- ▶ PTO 750 rpm.
- ▶ It requires a minimum power of 90 HP.
- ▶ Air exit adjustable on right and left position with hydraulic motor.
- ▶ Final deflector with hydraulic control.
- ▶ Front or rear.
- ▶ 330 m³/minut.
- ▶ Model built under EC Normative.
- ▶ Safety indicators visible to personnel.

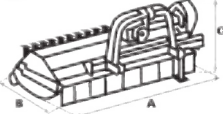

MODEL										PRICE
			KW-HP	A mm	A in	B mm	B in	C mm		
Turbina fixed	67-90	265	2315	91"	1320	52"	960	38"	750	9.088 €
330	67-90	320	2530	100"	1320	52"	1043	41"	750	13.440 €

OPTION			
2 nd Gearbox 540 rpm	781 €	2 nd Gearbox 1.000 rpm	781 €



SERRAT ADVANTAGES

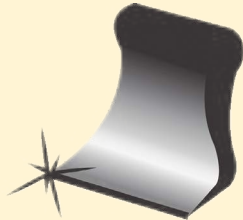

PYOLTEK



GIROSTOP

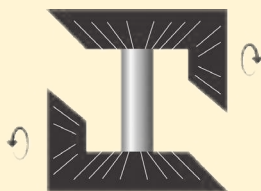

SYNKRODOS 600

SEKURLAST

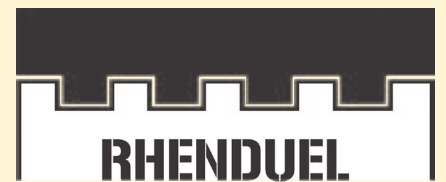

RHENDUEL



Pyoltek



Laser treatment in the tip of the hammer. Consumption area, it extends its duration generating a benefit as in hourly cost as in the reduction of time regarding the maintenance.





Bralakc



The BRALAKC feeder knives system is an exclusive design of SERRAT TRITURADORAS.

These exclusive feeder knives are the result of years of experience that SERRAT has developed in self-feeder mulchers.

Thanks to this innovative system we can obtain two essential factors collecting the pruning remains from the ground.

- ▶ Firstable, an absolute efficiency on the collection of the material thanks to the helical mounting system.
- ▶ On the other hand, thanks to its curved design, we can obtain a continuous feeding and without any obstruction, a fundamental factor in these type of machines when working in pruning cordons of high dimensions and volume.





Rotor Polser

**550
POLSER**

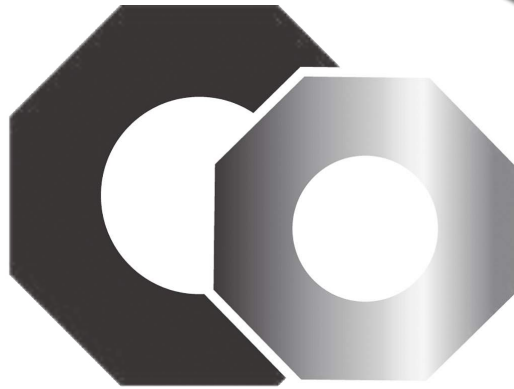

Ingenious rotor designed and manufactured in an octagonal shape providing more strength when the hammer reverses itself due to impacts.

Forged steel supports with high precision position guaranteeing a perfect operation and positioning of the cutting elements.

Gear plates of octagonal shape improving the power transmission. Internal plates to structure the rotor.

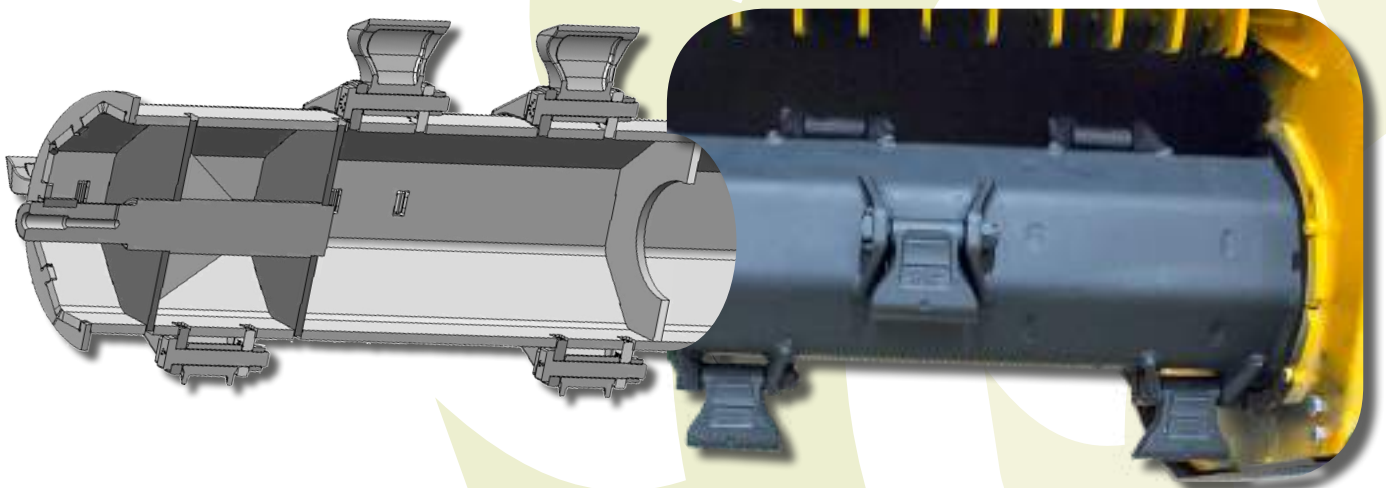



Girostop



The exclusive hammer coupling system with pivot GIROSTOP is the only one in this type of machines. The advantages are countless and below some of them:

- 1.º- Thanks to its square anchorage head, the pivot GIROSTOP never rotates in the hammer support. This advantage is very important because not turning, the hammer support will never be consumed and if the support in the lower part is not consumed it will increase the reliability of the rotor.
- 2.º- Thanks to the immobility of the pivot, the hammer is obligated to turn over the pivot and for that we can obtain that the bolt and the hammer do not get jammed because of dust and dirt.
- 3.º- The completely flat pivot head avoiding twist of cable or grass into it.
- 4.º- Thanks to this immobilization system, the maintenance and the change of the hammers will be much more safe and convenient.

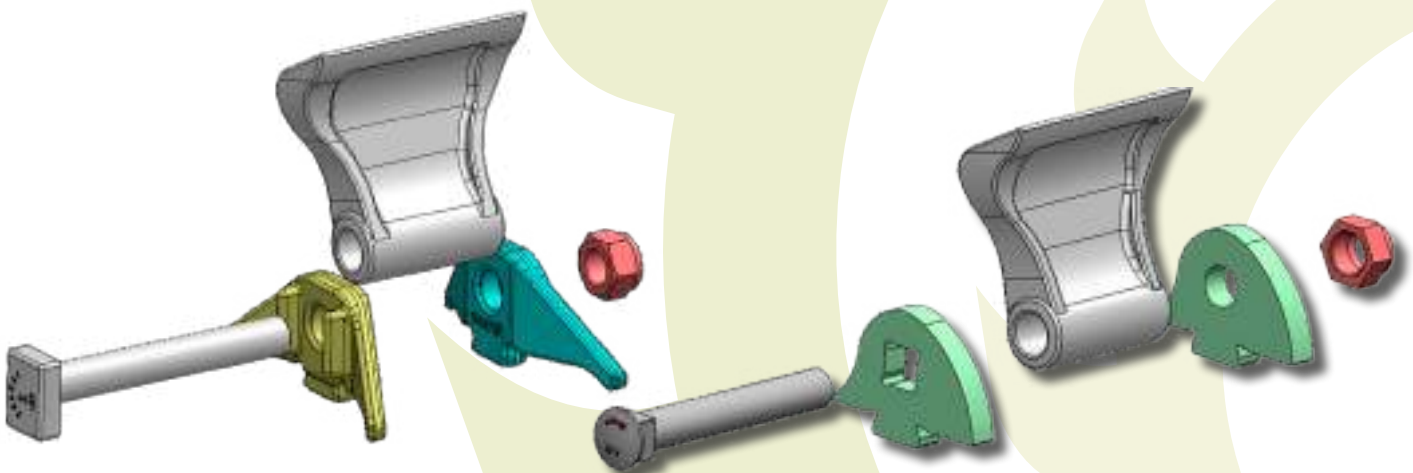



Rotor Polser +

**550 +
POLSER**

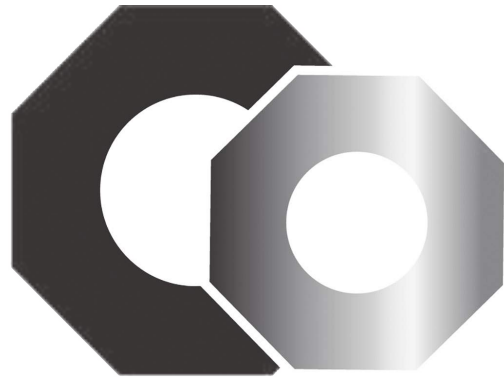

Forest rotor designed with the SERRAT polygonal section technology.

Rotor with swinging hammers at 360° inside the rotor.

The structural rigidity of this system avoiding damages during accidents, obtaining flexibility and rigidity at the same time.

The belting has been studied in protected spaces in order to avoid premature consumption during possible frictions with the ground. Internal plates are incorporated to reinforce the axis.

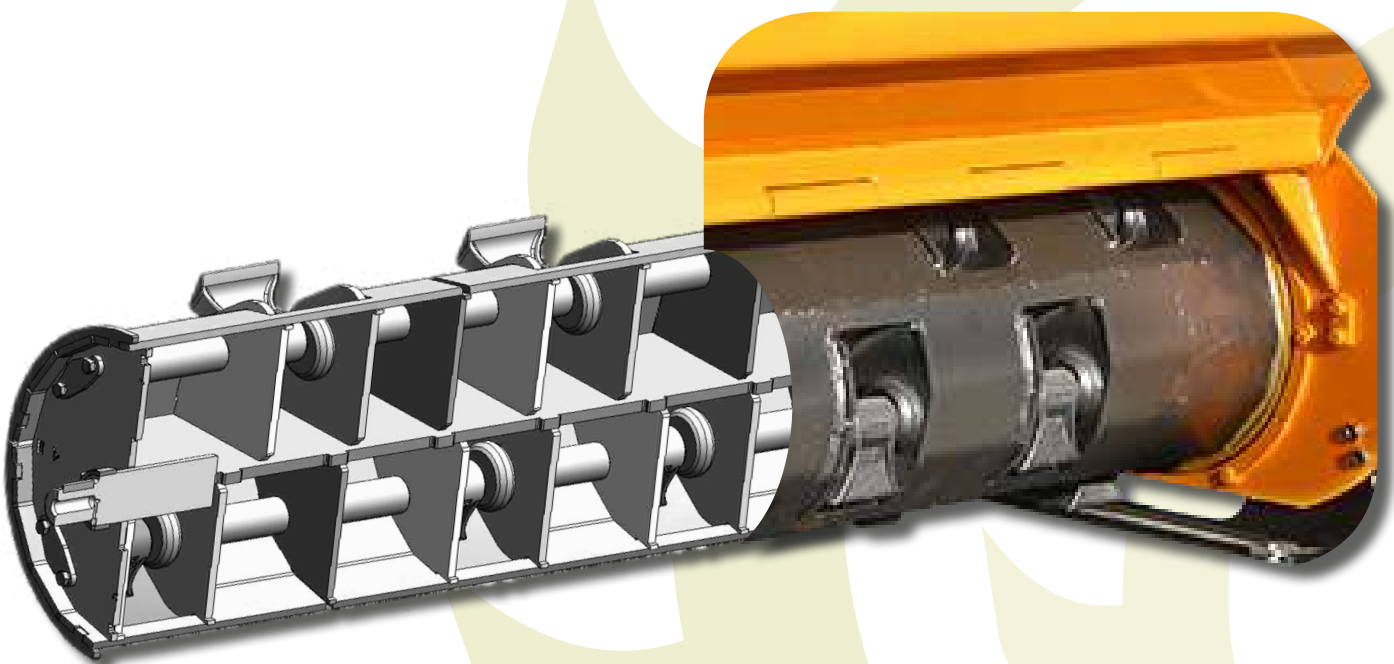



Synkrodos - 600



Synkrodos transmission system: it consists of a through input axis and two crows, which they engage into pinion axes; having in the same gearbox the double of power transmission capacity compared to the traditional gearbox. We have a pump to refrigerate the oil and there is the possibility of rear exit for combined equipments.

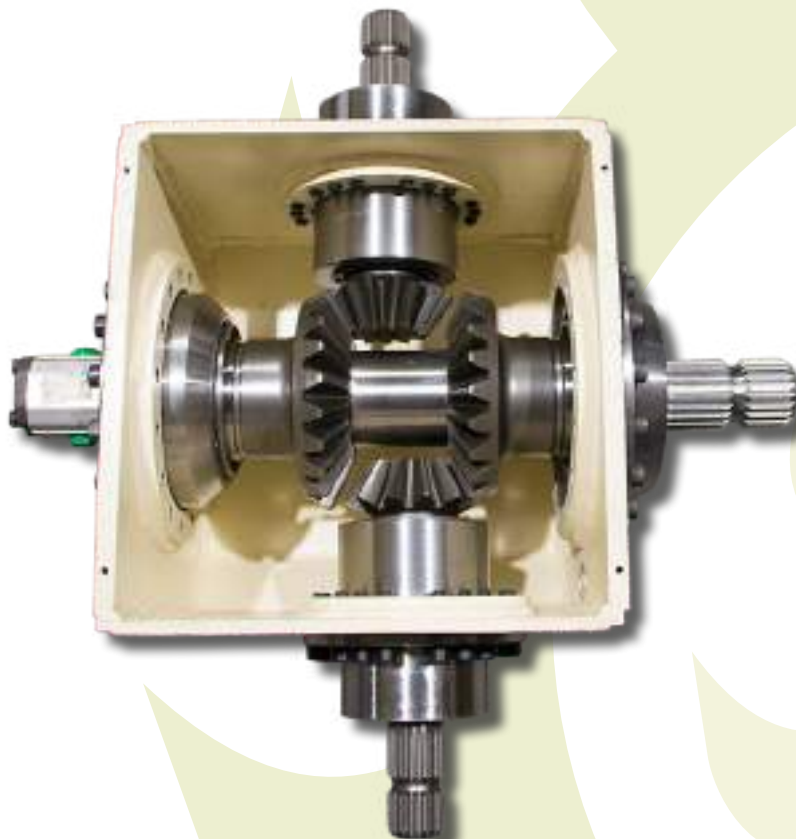



Rhenduel

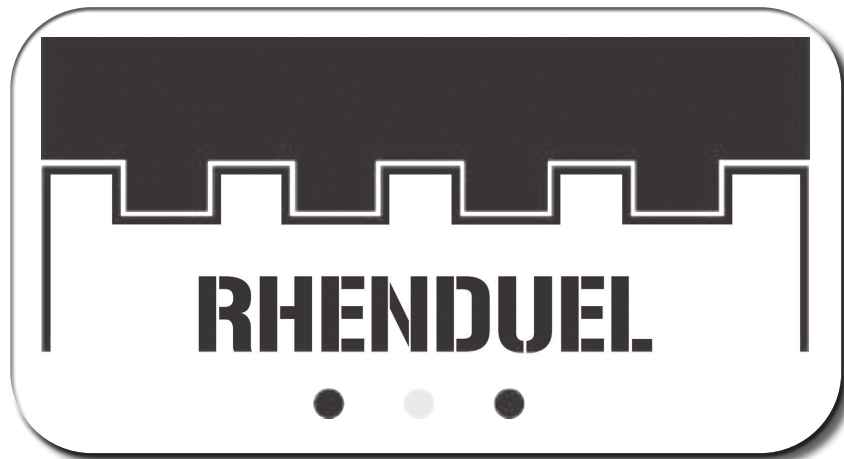

The RHENDUEL system is an ingenious perfect cutting system for self-feeder mulchers. Its main advantage is that with this system we can obtain a very fine chipwoods like sawdust thanks to its special blades. In addition, the power required by the tractor, to mulch with this system of blades, it can decrease up to 40 %, a very important factor to be taken into account to save fuel and save money.

Thanks to the fineness and the homogeneity of the chipwoods, it was possible to obtain that in machines with pneumatic charge like BIOMASS it were possible the transport through flexible and to load the material into biomass trailers.

It must be remembered that the fineness of the material, facilitates a multitude of activities in the field, for example:

- 1.^o- The incorporation of the woodchips into the ground is much faster with this system and in a short period of time the material will disappear from the ground.
- 2.^o- In nuts cultivation, where normally the harvest is mechanic, is fundamental to use these machines, because otherwise, we could have some problems during the harvest with big piece of wood causing large losses for the farmers.





Greasing System



Automatic lubrication system replaces traditional lubrication system, obtaining optimum lubrication, and can be programmable in quantity and lubrication interval.

This consists of a grease tank, driven by a high pressure pump, driven by a 12 V electric motor and controlled by a programmer for interval time.

The pipes are integrated into the chassis inside the fairings.





Hidrahelp



Hidrahelp is a hydraulic starter system for machines with heavy rotors, PTO without modulation in the ignition and in the front PTO.

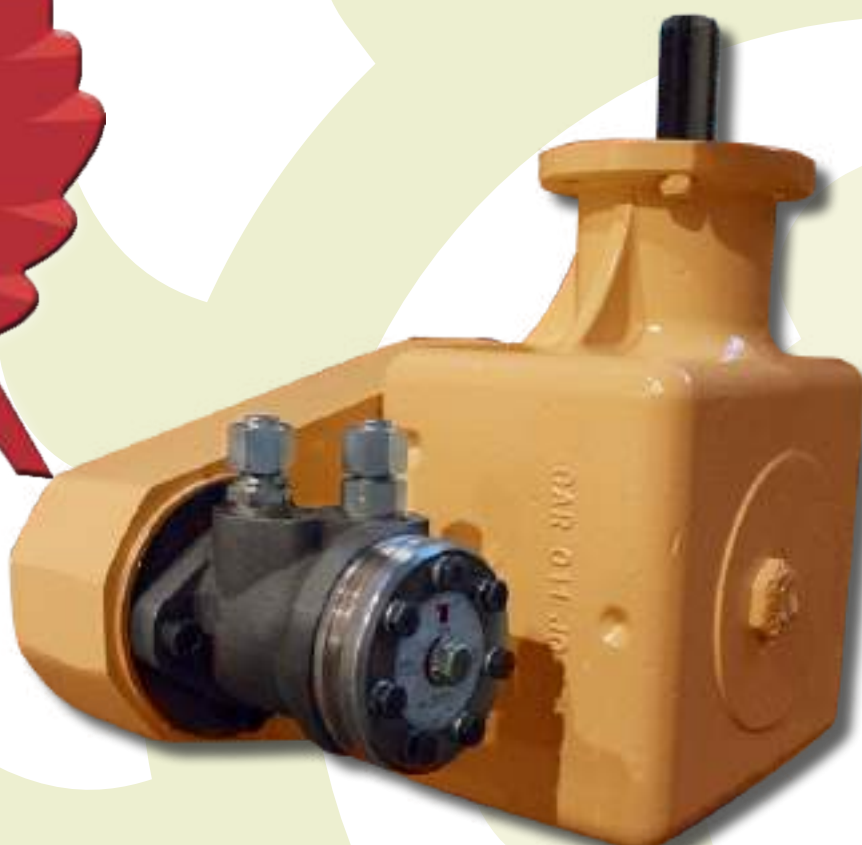



Rail Box

RAIL BOX

Automatic adaptation system of the transmission according to the position of the lifting, when the gear box is situated between the rotor and the tractor. Articulate the gearbox so that the angles of the transmission knots while working are lower.





Fixe Top

FIXE TOP

Fixe Top System: a system of cutting with teeth in tungsten, it's characterized by clamp screw not supporting the tooth; they fix it only so that it does not go out laterally. The effort due to the work neutralizes itself inside crenellations between the tooth and the support. The disposition in the rotor of the teeth allows that the heads of the screws are protected of the usage due to the erosion. The screws have two key anchors for when they erode with the ground.

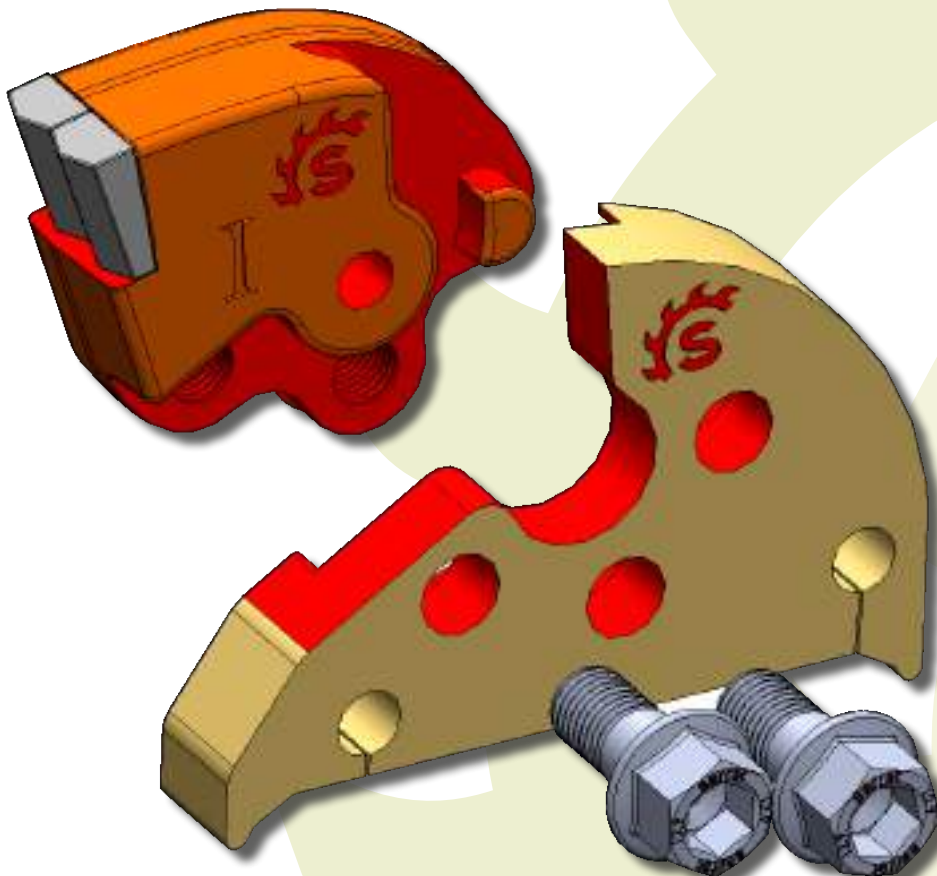



Splinter



Rotor with splinter blades: Its main characteristic is that this rotor with blades is made up of two spirals in which the effort is distributed throughout the entire rotor, giving it a very high rigidity. In addition, these blades are reversible, having two cutting edges. useful cut. It is a rotor intended for wood shredding works of pruning remains and clearing.





Sekurlast

SEKURLAST



Special project and design of the machine frame avoiding any throwing of material to the operator.

Our safety level exceeds the safety regulation 2006/42/CE by far.



GENERAL CONDITIONS OF SALE

1st - All the sales, as well as the delivery of the corresponding merchandise, are considered to be carried out to the complete satisfaction of the Buyer, in the warehouses established by the Seller both in this area as well as in other places. For this reason, the merchandise will always be transported at the expense and risk of the Buyer.

2nd - If the Buyer negotiates an Agricultural Loan to finance this purchase, the Seller will provide a proforma invoice or precise legal documents for the machine hired. For this purpose, the Buyer will give a letter to the Seller in duplicate addressed to the director of the bank where the Agricultural Loan has been requested, IRREVOCABLY demanding that the amount awarded for the Agricultural Loan will be credited solely and exclusively to the company SERRAT.

3rd - The receipt of the company SERRAT, of the Bill or Bills of exchange referred to in this contract, does not represent the payment of the price indicated, nor deferred, but the way in which it must fulfil its respective payment due dates, so that the Bills of Exchange, although being negotiated by the drawer, will only produce payment cheques when they have been settled by the Buyer.

4th - If due of force majeure or circumstances beyond the control of the Seller, the delivery of the merchandise is delayed by the means stipulated, the Seller will remain exempt from all responsibility, and the Buyer will not have the right to claim compensation for damages.

5th - The Seller reserves all rights to ownership of the merchandise sold until the completion of payment in the designated time.

6th - If any of the instalments are left unpaid, the Seller will be able, without further notice, to terminate the contract, and will be able to withdraw the machine sold, without any further notice or prior explanation.

7th - The Buyer accepts all warranty conditions set by the Seller. The conditions will be considered fulfilled by the company SERRAT if, on delivery, the Buyer accepts the material referred to, in accordance with the law.

8th - The guarantee entirely covers the replacement of faulty parts free of charge, but does not include the labour force or transport.

9th - All expenses justifiably generated and as the consequence of this commercial operation, judicially or extrajudicial, including in this case the fees for lawyers and solicitor rights not employed, will be paid by the Buyer.

10th - None of the conditions in this contract may be altered or cancelled by staff who work for the company, except with written authorisation to do so. Nor should a payment be made to someone who does not have written authorisation. Payments made without respecting this condition will be invalid. The Seller reserves the right to cancel this sale at any moment until the material hired has been delivered, and without being liable for this cancellation.

11th - Nevertheless, if the action of the previous clauses is established, the parties will be subject to the jurisprudence of the Courts and tribunals of Monzon, specifically waiving any other that may correspond to them.



EC DECLARATION OF CONFORMITY



SERRAT TRITURADORAS declara que los productos SERRAT son conformes a las disposiciones de la Directiva de Máquinas 2006/42/CE, Normas de Referencia UNE-EN 14121 y UNE-EN 12100.

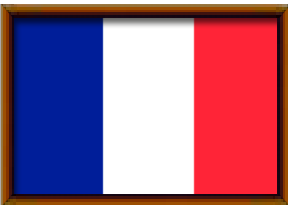

SERRAT TRITURADORAS déclare que les produits SERRAT sont conformes aux dispositions de la Directive de Machines 2006/42/CE, Normes de Référence UNE-EN 14121 et UNE-EN 12100.



SERRAT TRITURADORAS declares that products SERRAT are according to Machinery Directive regulations 2006/42/CE, Reference Standards UNE-EN 14121 and UNE-EN 12100.



SERRAT TRITURADORAS dichiara che i prodotti SERRAT sono conformi alle disposizioni della Direttiva di macchinaria 2006/42/CE, norme di referenza UNE-EN 14121 e UNE-EN 12100.



SERRAT TRITURADORAS declara que os produtos SERRAT estão de acordo com as Diretrizes de Máquinas 2006/42 / CE, Normas de Referência UNE-EN 14121 e UNE-EN 12100.



SERRAT TRITURADORAS заявляет, что продукция SERRAT соответствует положениям Директивы по машинам 2006/42/CE, справочным стандартам UNE-EN 14121 и UNE-EN 12100.



Follow us:

INSTAGRAM



YOUTUBE



FACEBOOK



WEB



All figures and illustrations contained in this manual are generic representations to be taken merely as graphic general information supplementing texts, without expecting from them any rigour in terms of measures, shapes or parts layout.

Notes



Horizontal lines for writing, partially obscured by a large, faint, light green graphic element on the right side of the page.



A series of horizontal lines for writing, with a large, faint, light green watermark of the word "SERRAT" overlaid on the right side of the page.



www.serrat.com
comercial@serrat.es
Tel. (+34) 974 417 830
Ctra. Nacional 240 km 149,3
22310 Castejón del Puente, Spain