



ZEPPELIN[®]
el poder de la tierra

2020

ZEPPELIN[®]

el poder de la tierra

Se solicita controlar **ESCRUPULOSAMENTE** la mercancía en el momento que llega, en caso de observar anomalías en el embalaje, hágalo notar en el albarán de entrega del transportista. En cualquier caso recomendamos escribir "mercancía pendiente de revisión".

Las reclamaciones imputables al transporte deberán comunicarse durante las 24 horas siguientes a la recepción de la mercancía. En caso de encontrar alguna anomalía ni imputable al transporte en la mercancía recibida, la reclamación se efectuará informando de la misma a Zeppelin Maquinaria, S.L., dentro de los 7 días laborables siguientes a su recepción.

La entrega del material, está siempre subordinada a que el ordenante esté en regla con los pagos de entregas anteriores.

No serán reconocidas las condiciones respecto a pedidos que no hayan sido aceptados o confirmados por Zeppelin Maquinaria, S.L. Zeppelin Maquinaria, S.L. podrá modificar sin necesidad de aprobación condiciones, productos y precios.

En devoluciones efectuadas por motivos no imputables a Zeppelin Maquinaria, S.L. se descontarán 14 euros por cada unidad devuelta, además de los costes del transporte de la mercancía, además de la penalización sobre el valor de ésta, a determinar por Zeppelin Maquinaria, S.L.

Consulte condiciones para envíos a porte pagado.

Fotos no contractuales.

Los precios de este catálogo son PVP sin IVA, salvo error tipográfico.





Con el fin de mejorar permanentemente la calidad de nuestros productos, Zeppelin Maquinaria se reserva el derecho de modificar sus características y vigencia de este catálogo en cualquier momento y sin previo aviso.

Condiciones de venta y más info en www.zeppelinmaquinaria.es.

"Zeppelin, the power of the land" es una marca registrada. En este catálogo aparece como Zeppelin[®].

ZEPPELIN®

el poder de la tierra

-  MAQUINARIA AGRÍCOLA
-  MACHINERIE AGRICOLE
-  MAQUINARIA AGRÍCOLA
-  AGRICULTURAL MACHINERY

2020

www.zepelinmaquinaria.es

"Zeppelin, the power of the land" es una marca registrada. En este catálogo aparece como Zeppelin®.



CENTRO LOGÍSTICO II: Polígono Industrial Malpica Calle E, nave 7- 50016 ZARAGOZA (Spain) Tel.: +34 662 147 567



SEDE CENTRAL: Plataforma Logística Zaragoza PLAZA.
c/ Tarento, 12 - 50197 ZARAGOZA (Spain)
Tel.: +34 876 269 494 - Fax: +34 876 269 495



CENTRO LOGÍSTICO III: Polígono O Ceao - Avda. Benigno Rivera, nave 62
27003 LUGO (Spain) Tels.: +34 982 256 727 · +34 639 955 747

PVP. IVA NO INCLUIDO

www.zepelinmaquinaria.es

TRITURADORAS A TOMA DE FUERZA PARA TRACTOR

Broyeur à coteaux/ Triturador de lâminas / Flail mower blades

KALAHARI



Trituradora ideal para hierba, espacios verdes, huerto e invernaderos.

Broyeur idéal pour l'herbe, les espaces verts, verger et serres. /
Triturador ideal para erva, espaços verdes, pomar e estufas. /
Flail mower ideal for grass, green spaces, orchard and greenhouses.

Enganche fijo 3er Punto. Multiplicador en fundición y con Rueda Libre.
Equipada con cuchillas. Rodillo Trasero con Limpiador/Raspador.
Cardan y Bulones incluidos. Patines Laterales.

Attelage fixe 3 points. Boîtes d'engrenages en fonte avec roue libre intégrée.
Équipé des lames en forme de Y. Rouleau arrière avec un nettoyeur/grattoir.
Cardan et boulons inclus. Talons latéraux.

3 point attachment. Cast made gearbox with free wheel.
Equipped with blades Y-shaped. Rear roller with cleaner/scrapper.
Cardan and bolts included. Side skates.

Acoplamento fixo 3º ponto. Grupo em ferro fundido e com roda livre.
Equipado com lâminas. Rolo traseiro com limpador / raspador.
Cardan e parafusos incluídos. Patins Laterais.

Referencia	mm	Kg			Ø Rotor	hp	PTO r/min	A	B	C	€
ESTR085Z	800	125	30	2	76	10-20	540	678 mm	950 mm	722 mm	1.040 €
ESTR095Z	900	140	30	2	76	10-20	540	678 mm	1050 mm	722 mm	1.076 €
ESTR105Z	1050	150	36	2	76	20-30	540	678 mm	1150 mm	722 mm	1.213 €
ESTR125Z	1229	170	42	2	76	25-30	540	678 mm	1350 mm	722 mm	1.260 €
ESTR155Z	1529	210	54	3	76	30-40	540	678 mm	1650 mm	722 mm	1.397 €
ESTR175Z	1729	255	60	3	76	30-40	540	678 mm	1850 mm	722 mm	1.628 €



Cuchillas dobles reforzadas.



Grupo de fundición.



Correas 1ª calidad.



Bulones incluidos.

Dimensiones

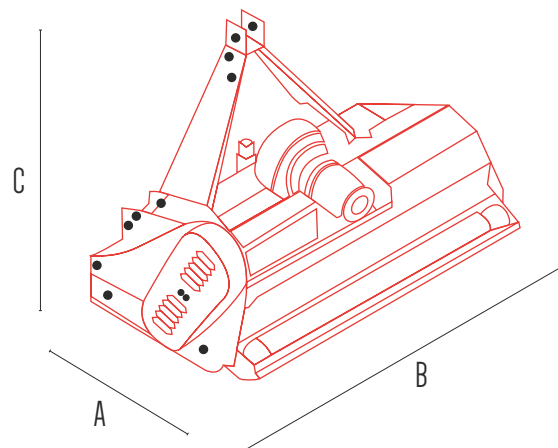

TRITURADORAS A TOMA DE FUERZA PARA TRACTOR

Broyeur à marteaux/ Triturador de martelos / Flail mower hammers



Tipo MZ.



MARTILLOS
MARTEAUX /
MARTELOS / HAMMERS



Tipo MZA. Arco Tripuntal

Trituradora fija ideal para hierba, viña, huerto e invernadero. Tritura broza y resto de poda hasta 5 cm de diámetro.

Broyeur idéal pour l'herbe, les vignobles, verger et serres. Broyage des restes d'élagage jusqu'à 5 cm de diamètre. /

Triturador fijo ideal para restos de poda, vinha, pomar e estufa. Tritura restos da poda até 5 cm de diámetro. /

Flail mower ideal for grass, green spaces, orchard and greenhouses. Shredding of pruning up to 5 cm diameter.

- Grupo reforzado de fundición. Equipada con Martillos (Opcional cuchillas)
 Rodillo Trasero con Limpiador/Rascador. Cardan y Bulones incluidos.
 Patines laterales Regulables. Apertura Trasera Regulable. Correas ajustables.

- Reinforced cast made gearbox. Equipped with hammers (blades in option).
 Rear roller with cleaner/scrapper. Cardan and bolts included.
 Adjustable side skates. Adjustable rear opening. Adjustable transmission belts.

- Boîtier d'engrenages en fonte renforcé. Équipé marteaux(lames en option).
 Rouleau arrière avec un nettoyeur/grattoir. Cardan et boulons inclus.
 Talons latéraux réglables. Capot arrière ouvrable. Courroies réglables.

- Grupo de Fundação Reforçada. Equipado com martelos (lâminas opcionais)
 Rolo Traseiro com Limpador / Raspador. Cardan e parafusos incluídos.
 Patins laterais ajustáveis. Abertura Traseira Ajustável. Correas ajustáveis.

Referencia	mm	Kg			Ø Rotor	hp	PTO r/min	A	B	C	€
ESTRGC105MZ	1020	250	3	16	108	18-25	540	920 mm	1170 mm	950 mm	1.806 €
ESTRGC125MZ	1220	277	3	20	108	18-25	540	920 mm	1370 mm	950 mm	1.848 €
ESTRGC155MZ	1520	322	3	24	108	30-40	540	920 mm	1670 mm	950 mm	1.922 €
ESTRGC175MZ	1720	359	3	28	108	40-50	540	920 mm	1870 mm	950 mm	2.006 €

Arco Tripuntal

ESTRGC085MZA	850	180	3	14	108	10-20	540	920 mm	920 mm	950 mm	1.590 €
ESTRGC105MZA	1050	230	3	16	108	25-55	540	920 mm	1170 mm	950 mm	1.870 €
ESTRGC125MZA	1250	249	3	20	108	25-55	540	920 mm	1370 mm	950 mm	1.976 €
ESTRGC155MZA	1550	276	3	24	108	30-55	540	920 mm	1670 mm	950 mm	2.117 €
ESTRGC175MZA	1750	294	3	28	108	30-55	540	920 mm	1870 mm	950 mm	2.272 €

Dimensiones

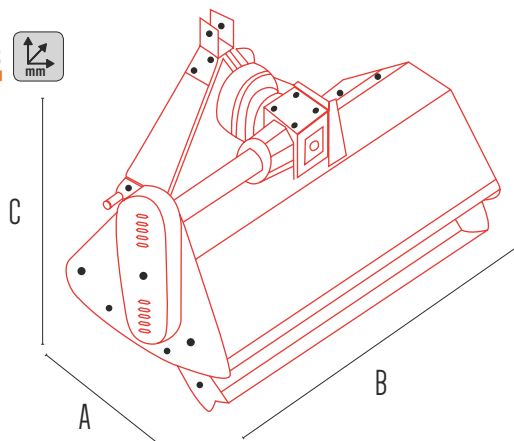

Tensor correas.



Martillos.



Correas 1ª calidad.

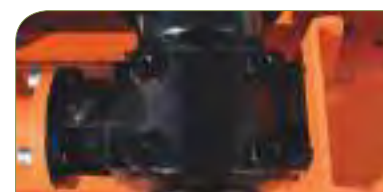

Grupo reforzado fundición.

TRITURADORAS DESPLAZABLES

Broyeur déportable à marteaux / Triturador de martelos / Side shift flail mower hammers

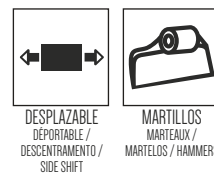

Trituradora para hierba, resto de poda fina. Hasta 5 cm.

Broyeur pour l'herbe et les restes d'élagage léger. Jusqu'à 5 cm. / Triturador para erva, resto de poda. Ate 5 cm. / Side shift flail mower for grass and thin pruning. Up to 5 cm.

Enganche desplazable hidráulico. Grupo reforzado Fundición con Rueda Libre. Rodillo trasero con limpiador/rascador. Apertura trasera regulable. Opcional montaje de cuchillas. Cardan y Bulones incluidos.

Hydraulic displacement. Reinforced cast made gearbox with free wheel. Rear roller with cleaner/scrapper. Adjustable rear opening. Equipped with hammers (blades in option). Cardan and bolts included.

Déport hydraulique 3 points. Boîtier d'engrenages en fonte renforcé avec roue libre intégrée. Rouleau arrière avec un nettoyant/grattoir. Capot arrière ouvrable. Équipé de marteaux (lames en option). Cardan et boulons inclus.

Com Descentramento hidráulico. Reforçado grupo de fundição com roda livre. Rolo traseiro com limpador/raspador. Abertura traseira ajustável. Equipado com martelos (Lâminas opcionais). Cardan e parafusos incluídos.

Referencia	mm	Kg		Ø Rotor	hp	PTO r/min	A	B	C	Desplazamiento mm	€	
ESTRDESP125MZ	1220	312	3	20	108	18-25	540	790 mm	1365 mm	850 mm	348	2.037 €
ESTRDESP155MZ	1520	332	3	24	108	30-40	540	790 mm	1665 mm	850 mm	348	2.247 €
ESTRDESP175MZ	1720	387	3	28	108	40-50	540	790 mm	1865 mm	850 mm	348	2.541 €

Dimensiones

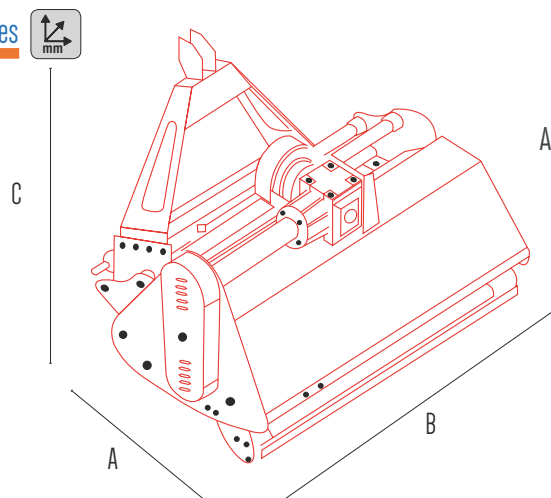

Apertura ajustable.



Correas 1ª calidad.



Tensor correas.



Patines ajustables en altura.



Grupo reforzado fundición.

TRITURADORA DESPLAZABLE CON DISCO LATERAL HIDRÁULICO

Broyeur déportable à marteaux / Triturador de martelos / Side shift flail mower hammers

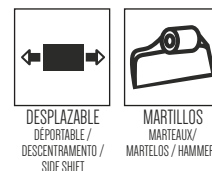

**CON DISCO
DESBROZADOR
LATERAL**

Ver vídeo Canal Zeppelin Maquinaria

Trituradora para hierba, resto de poda fina. Hasta 5 cm.

Broyeur pour l'herbe et les restes d'élagage léger. Jusqu'à 5 cm. / Triturador para erva, resto de poda. Até 5 cm. / Side shift flail mower for grass and thin pruning. Up to 5 cm.

- Permite un acabado perfecto del terreno mediante el disco de desbrozado lateral de dos cuchillas. Gracias a su sistema hidráulico y el brazo autoadaptable el disco lateral trabaja el borde de los frutales, olivos y lindes en perfecto acabado.
- Le disque latéral à deux lames permet une finition parfaite. Grâce au système hydraulique et le bras auto-adaptable, le disque peut atteindre le bord des arbres fruitiers, des oliviers et les bordures des champs.

- This lateral disc with two blades allows a cutting with perfect finishing. Thanks to the hydraulic system and self-adaptable arm, the disc can reach the edge of fruit and olive trees, and field borders.
- Permite um perfeito acabamento do terreno por meio do disco de corte lateral de duas lâminas. Graças ao seu sistema hidráulico e ao braço auto-adaptável, o disco lateral trabalha na borda das árvores frutíferas, oliveiras e bordas em perfeito acabamento.

Referencia	mm	Kg			Ø Rotor	hp	PTO r/min	A	B	C	Desplazamiento mm	€
ESTRDESP125ZCDH	1250	322	3	20	108	25-55	540	500 mm	1370 mm	1650 mm	175	3.875 €
ESTRDESP155ZCDH	1550	352	3	24	108	30-55	540	500 mm	1670 mm	1650 mm	200	4.030 €
ESTRDESP175ZCDH	1750	372	3	28	108	30-55	540	500 mm	1870 mm	1650 mm	200	4.216 €

Dimensiones

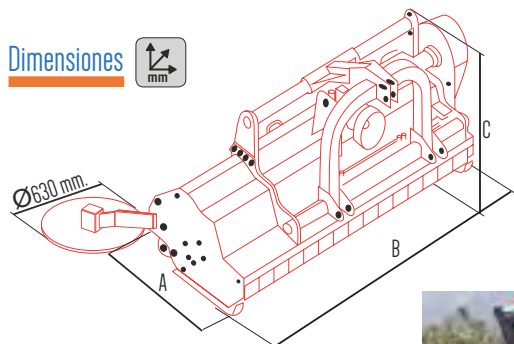

KIT Disco y latiguillos hidráulicos
KIT set disque / KIT disco e latiguillos. / KIT disc

Referencia	Kg	€
ES71639	60	895 €



Sistema hidráulico con depósito.



Disco y brazo acoplado.

Ø 630 mm.

TRITURADORAS REFORZADAS DESPLAZABLES

Broyeur déportable renforcé à marteaux / Tritrador de martelos / Reinforced side shift flail mower hammer

MOJAVE
REFORZADA

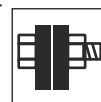

REFORZADO
REINFORCE /
REFORÇADO /
REINFORCED

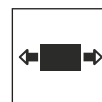

DESPLAZABLE
DEPORTABLE /
DESCENTRAMENTO /
SIDE SHIFT

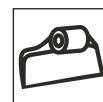

MARTILLOS
MARTEAUX /
MARTELOS /
HAMMERS



Ver vídeo Canal Zeppelin Maquinaria

Trituradora para hierba y resto de poda. Resto de poda de hasta 7 cm.

Broyeur déportable renforcé pour l'herbe et les restes d'élagage jusqu'à 7 cm de diamètre. / Tritrador de resto de poda de vinha e pomares. Resto de poda 7 cm. / Offset Flail mower for grass and pruning up to 7 cm. diameter.

ESPECIAL OLIVAR

Enganche desplazable hidráulico. Grupo de fundición reforzado con Rueda Libre.

Rodillo trasero con rascador/limpiador. Apertura trasera regulable.

Opcional Montaje de Cuchillas. Cardan y Bulones incluidos.

Déport hydraulique 3 points. Boîtier d'engrenages en fonte renforcé avec roue libre intégrée. Rouleau arrière avec un nettoyeur/grattoir. Capot arrière ouvrable.

Équipé marteaux (lames en option). Cardan et boulons inclus.

Hydraulic displacement. Reinforced cast made gearbox with free wheel. Rear roller with cleaner/scrapper. Adjustable rear opening. Equipped with hammers (blades in option). Cardan and boluns included.

Descentramento hidraulico. Grupo de fundição reforçado com roda livre. Rolo traseiro com raspador / limpiador. Abertura traseira ajustável. Conjunto opcional de lâminas. Cardan e parafusos incluídos.

Referencia	mm	Kg			Ø Rotor	hp	PTO r/min	A	B	C	Desplazamiento mm	€
ESTRDESP170REF	1690	458	3	16	127	40-70	540	972 mm	1850 mm	1055 mm	348	3.140 €
ESTRDESP200REF	1990	590	4	18	127	70-90	540	972 mm	2120 mm	1055 mm	348	3.623 €
ESTRDESP220REF	2190	650	4	20	127	80-100	540	972 mm	2330 mm	1055 mm	348	3.860 €



Dimensiones

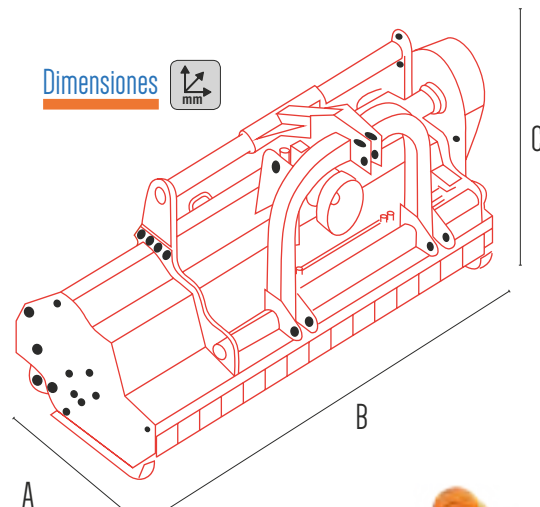

Martillos reforzados.



Grupo de fundición.



Patines regulables.



Tensor de correas.



Correas 1ª calidad.

TRITURADORAS SUPER REFORZADAS DESPLAZABLES

Broyeur déportable super-renforcé à marteaux / Triturador de martelos / Super reinforced side shift flail mower hammers



SUPER REFORZADA

DESPLAZABLE

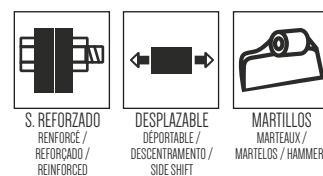

Trituradora con desplazamiento hidráulico. Resto de poda de hasta 10 cm.

Broyeur pour les restes d'élagage jusqu'à 10 cm de diamètre. / Triturador com descentramento hidráulico. Resto de poda 10 cm. / Offset Flail mower for pruning up to 10 cm diameter.

ES Chasis super reforzado (10 mm). 5 Correas primera calidad. Optima para frutales, viñedos, olivar, etc. Grupo Reforzado con Rueda Libre. Cardan y Bulones incluidos.

DK Super reinforced chassis (10 mm). 5 top quality transmission belts. Ideal for fruit trees, vineyards, olive trees, etc. Reinforced cast made gearbox with free wheel. Cardan and bolts included.

FR Châssis super renforcé (10 mm). 5 courroies de première qualité. Idéal pour les arbres fruitiers, les vignobles, les oliviers, etc. Boîtier d'engrenages en fonte renforcé avec roue libre intégrée. Cardan et boulons inclus.

PT Chassi super reforçado (10 mm). 5 correias de primeira qualidade. Ideal para árvores de frutos, vinhas, olivais, etc. Grupo Reforzado com Roda Livre. Cardan e parafusos incluídos.

Referencia	mm	Kg			Ø Rotor	hp	PTO r/min	A	B	C	Desplazamiento mm	€
ESTRDESP200SREF	1990	610	5	20	152	70-100	540	900 mm	2150 mm	1000 mm	500	3.974 €
ESTRDESP220SREF	2190	646	5	24	152	80-100	540	900 mm	2350 mm	1000 mm	500	4.179 €
ESTRDESP240SREF	2390	686	5	24	152	80-100	540	900 mm	2550 mm	1000 mm	500	4.557 €

Dimensiones

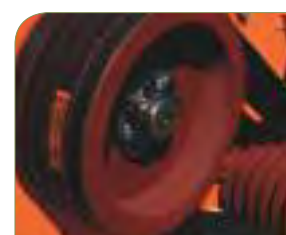
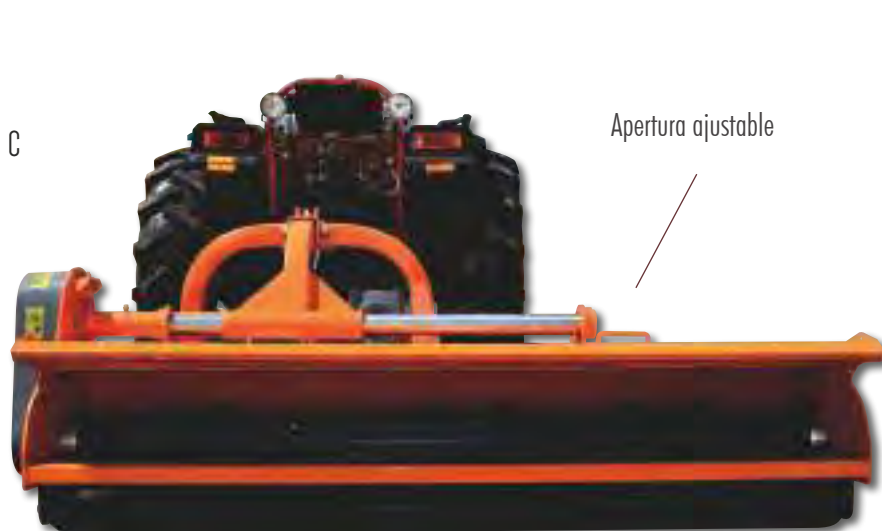
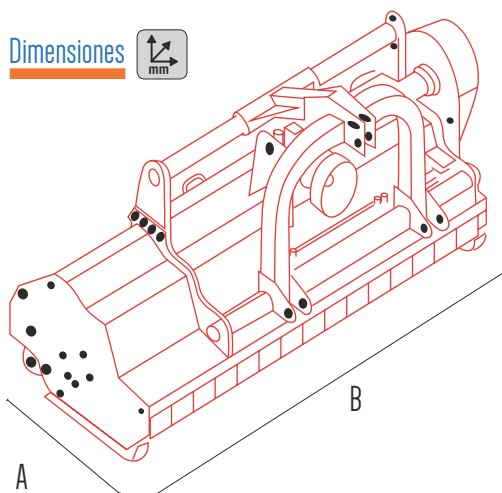

Grupo reforzado fundición. Patines regulables en altura.

Martillos.

Tensor de correas.

Correas 1ª calidad.

TRITURADORA DESPLAZABLE REVERSIBLE

Broyeur déportable et réversible à marteaux / Triturador reversivel de martelos / Reversible drive side shift flail mower hammers

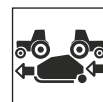

REVERSIBLE
REVERSIBLE /
REVERSIVEL /
REVERSIBLE

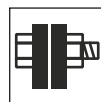

REFORZADO
REINFORCE /
REFORÇADO /
REINFORCED

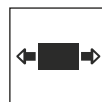

DESPLAZABLE
DEPORTABLE /
DESCENTRAMENTO /
SIDE SHIFT

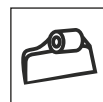

MARTILLOS
MARTEAUX /
MARTELOS /
HAMMERS



**2,4
METROS**

**DESPLAZABLE
REVERSIBLE**



Trituradora para poda y ramas gruesas. HASTA 10 CM.

Un broyeur puissant pour l'élagage et les branches épaisses. Jusqu'à 10 cm. / Triturador Reforzado para poda e Ramos grossos. Ate 10 cm. / Reversible drive flail mower for gross thickness pruning. Up to 10 cm.

Potente trituradora para poda y ramas gruesas. Grupo reversible. Doble tripuntal reforzado. Rodillo trasero de nivelación. Desplazable 500 mm.

Un broyeur puissant pour l'élagage et les branches épaisses. Boîtier d'engrenages réversible. 3^{ème} point double renforcé. Rouleau niveleuse arrière. Déplacement 500 mm.

A powerful mower for pruning and thick branches. Reversible gearbox. Double reinforced third point. Rear levelling roller. Displacement 500 mm.

Triturador com deslocamento hidráulico, até 500mm. Triturador Reforzado para poda e Ramos grossos. Rolo de nivelamento traseiro. Chassi super reforçado (10 mm). Cardan e parafusos incluídos.

Referencia	mm	Kg			Ø Rotor	hp	PTO r/min	A	B	C	€
ESTRGC240ZREV	2390	600	4	24	152	+90	540	1030 mm	2460 mm	1000 mm	4.400 €

Dimensiones

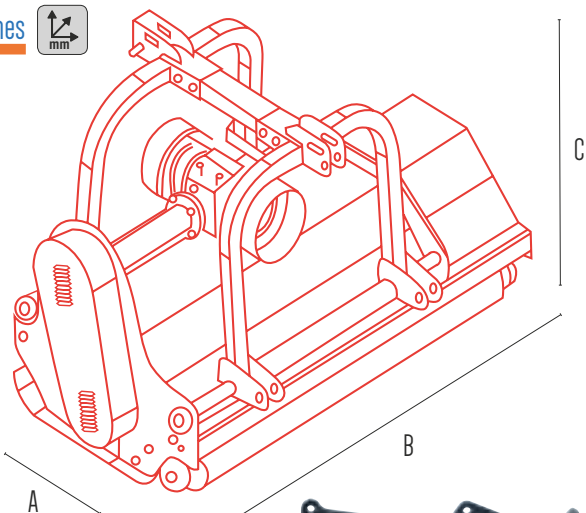

Ajuste de correas.



Patines regulables en altura.



Grupo reforzado fundición.



Correas 1ª calidad.

TRITURADORA FIJA REVERSIBLE

Broyeur réversible à marteaux / Triturador reversivel de martelos / Reversible drive flail mower hammers



3 METROS

FUA REVERSIBLE



Trituradora para poda y ramas gruesas. HASTA 10 CM.

Broyeur fixe réversible pour les restes d'élagage dine grande épaisseur. Jusqu'à 10 cm. / Trituradora de martelos reversivel fixa. Ate 10 cm. / Reversible drive flail mower for gross thickness pruning. Up to 10 cm.

ES Potente trituradora para poda y ramas gruesas.

Espesor de la chapa: 10 mm laterales.

Tripuntal reversible. Protector de caucho antigrava.

FR Un broyeur puissant pour l'élagage et les branches épaisses.

Tôles latérales super renforcées (10 mm).

3^{ème} point réversible. Protecteur en caoutchouc anti-gravier.

UK A powerful mower for pruning and thick branches.

Super reinforced side plates (10 mm).

Reversible third point. Anti-gravel rubber protector.

PT Trituradora Potente para poda e ramas grossas.

Espesura 10 mm Laterais.

Terceiro ponto reversivel. Protetor de borracha anti-cascalho.

Referencia	mm	Kg	mm	mm	Ø Rotor	hp	PTO r/min	A	B	C	€	
ESTRGC300SREFV	3000	1230	5	30	(1.65kg)	194	+100	540	1100 mm	3080 mm	800 mm	5.400 €

Dimensiones

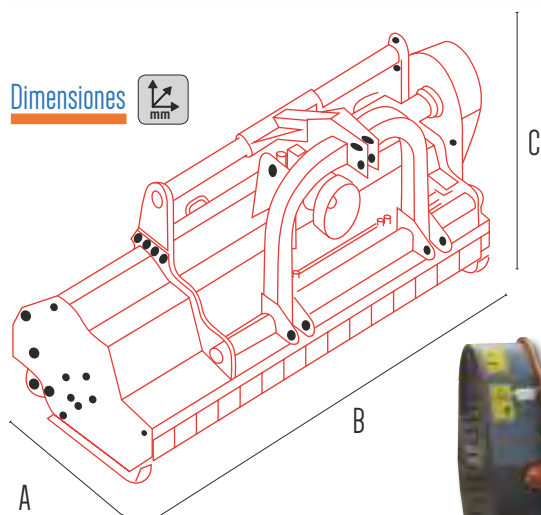

Correas 1ª calidad.



Tensor de correas.



Grupo reforzado fundición.



Martillos Reforzados.

TRITURADORAS GRAN VOLUMEN ESPECIAL VIÑA

Broyeur à marteaux spécial pour le vignoble / Triturador de martelos especial vinha / Flail mower special for vineyard



**ESPECIAL
VIÑA**



MARTILLOS
MARTEAUX /
MARTELOS / HAMMERS

**PORTÓN
REGULABLE Y
RASTROJEROS**

**FUJA
Y
COMPACTA**

Trituradora Gran Volumen. HASTA 15 CM.

ESTRGV100AP

Broyeur déportable à haute capacité. **Tiges de ramassage et capot arrière.** Jusqu'à 15 cm. / Triturador de grande volume. **Recolhendo ancinhos e abertura traseira ajustável.** Ate 15 cm. / High capacity side shift flail mower. **Collecting rakes and adjustable rear opening.** Up to 15 cm.

Perfecta para generar biomasa de la poda de árboles frutales en pequeñas y medianas extensiones. Su reducido tamaño y su gran capacidad de triturado hace que un tractor compacto y potente la pueda manejar. Acceso externo más cómodo a engrase de ejes de correas.

Parfaite pour la production de biomasse à partir de la taille des arbres fruitiers dans les petites et moyennes surfaces. Sa petite taille et sa grande capacité de broyage la rendent parfaite pour tout tracteur compact et puissant. Accès externe plus facile au graissage des arbres de courroie.

Perfect for biomass generation from the fruit trees pruning in small and medium areas. Its small size and large crushing capacity makes it perfect for any compact and powerful tractor. Easier external access to belt shaft greasing.

Perfeito para gerar biomassa a partir da poda de árvores frutíferas em pequenas e médias extensões. O tamanho pequeno e a sua grande capacidade de trituração significa que um trator compacto e potente pode realizar na perfeição o seu trabalho. Acesso externo mais confortável para lubrificar eixos de correias.

Referencia	mm	Kg	Ø Rotor		PTO r/min	hp	A	B	C	€
ESTRGV100AP	1.000	480	5 168	7 8	540	40/70	1050 mm	1160 mm	1100 mm	2.475 €
ESTRGV120AP	1.190	520	5 168	8 10	540	40/70	1050 mm	1350 mm	1100 mm	3.068 €
ESTRGVD120AP	1.190	520+60	5 168	8 10	540	40/70	1050 mm	1350 mm	1100 mm	3.756 €

Dimensiones

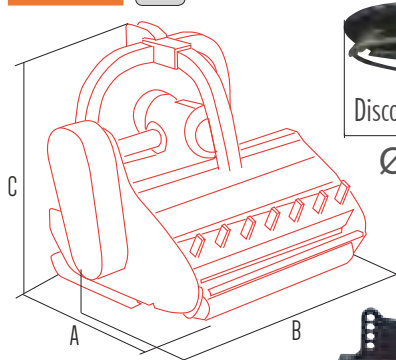

Disco y brazo acoplado.
Ø 630 mm.



**CON DISCO
DESBROZADOR**

ESTRGVD120AP. Con disco desbrozador



Grupo reforzado fundición.



Patines regulables en altura.



Ajuste de correas.



Martillos

TRITURADORAS GRAN VOLUMEN DESPLAZABLE

Broyeur déportable à haute capacité / Triturador de grande volume com deslocamento hidráulico. / High capacity side shift flail mower

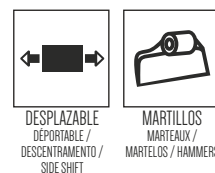

Desplazable Gran Volumen desplazable. HASTA 15 CM.

Broyeur déportable à haute capacité avec des tiges de ramassage. Jusqu'à 15 cm. / Triturador de grande volume. Ate 15 cm. / High capacity side shift flail mower with collecting rakes. Up to 15 cm.

DESPLAZABLE CON RASTROJEROS

Gracias al grupo y las 5 correas la Great Canyon transmite a los martillos gran potencia con tractores de más de 50 hp. Desplazamiento 500 mm.

Because of its gearbox and 5 transmission belts, the Great Canyon transmits a great power to the hammers, ideal for tractors over 50hp. Displacement 500 mm

En raison de son boîtier d'engrenages et des 5 courroies, la Great Canyon transmet aux marteaux une grande puissance, idéale pour les tracteurs de plus de 50hp. Déplacement 500 mm.

Grças ao grupo de engrenagens e ás 5 correias, Great Canyon transmite aos martelos grande poder, tratores de mais de 50 hp. Deslocamento hidráulico até 500mm.

Desde 1.50 m. hasta 2.40 m.

Referencia	mm	Kg	Ø Rotor	PTO r/min	hp	A	B	C	Desplazamiento mm	€	
ESTRDESPGV150Z	1500	640	5 168	10 15	540	50/80	1050 mm	1650 mm	1100 mm	500	3.590 €
ESTRDESPGV190Z	1900	664	5 168	13 20	540	50/80	1050 mm	2050 mm	1100 mm	500	3.728 €
ESTRDESPGV200Z	2000	683	5 168	13 20	540	50/80	1050 mm	2165 mm	1100 mm	500	3.875 €
ESTRDESPGV220Z	2200	725	5 168	15 24	540	60/80	1050 mm	2365 mm	1100 mm	500	4.074 €
ESTRDESPGV240Z	2400	763	5 168	17 24	540	60/90	1050 mm	2565 mm	1100 mm	500	4.280 €

Dimensiones

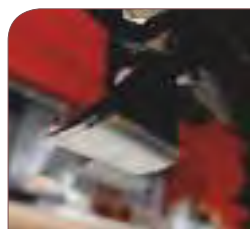
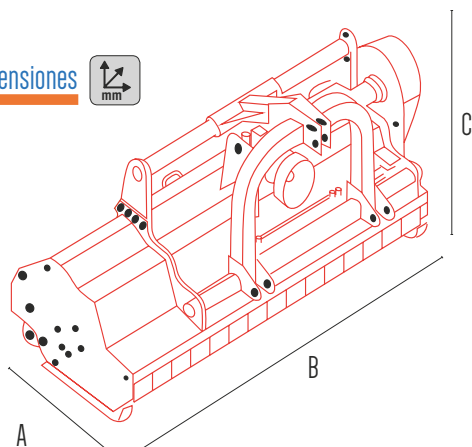

Martillos.



Ajuste de correas.



Correas 1ª calidad.



Grupo reforzado fundición.

TRITURADORAS GRAN VOLUMEN DESPLAZABLE

Broyeur déportable à haute capacité / Tritador de grande volume com deslocamento hidráulico / High capacity side shift flail mower



DESPLAZABLE PORTÓN REGULABLE Y RASTROJEROS

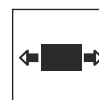

DESPLAZABLE
DEPORTABLE /
DESCENTRAMENTO /
SIDE SHIFT

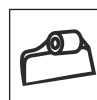

MARTILLOS
MARTEAUX /
MARTELOS / HAMMERS



Trituradora Gran Volumen desplazable. HASTA 15 CM.

Broyeur déportable à haute capacité. **Tiges de ramassage et capot arrière.** Jusqu'à 15 cm. / Tritador de grande volume. **Recolhendo ancinhos e abertura traseira ajustável. Ate 15 cm.** / High capacity side shift flail mower. **Collecting rakes and adjustable rear opening.** Up to 15 cm.

Gracias al grupo y las 5 correas la trituradora transmite a los martillos gran potencia con tractores de más de 50 hp. Desplazamiento 500 mm.

Because of its gearbox and 5 transmission belts, the Great Canyon transmits a great power to the hammers, ideal for tractors over 50hp. Displacement 500mm.

En raison de sa Boîtier d'engrenages et les 5 courroies, la Great Canyon transmet aux marteaux une grande puissance, idéal pour les tracteurs de plus de 50hp. Déplacement 500 mm.

Grças ao grupo de engrenagens e ás 5 correias, Great Canyon transmite aos martelos grande poder, tratores de mais de 50 hp. Deslocamento hidráulico até 500mm.

Referencia	mm	Kg	Ø	Rotor	PTO r/min	hp	A	B	C	Desplazamiento mm	€		
ESTRDESPGV200AP	2000	684	5	168	14	20	540	50/80	1050 mm	2150 mm	1100 mm	500	4.075 €
ESTRDESPGV220AP	2200	725	5	168	14	24	540	60/80	1050 mm	2350 mm	1100 mm	500	4.318 €
ESTRDESPGV240AP	2400	769	5	168	16	24	540	60/90	1050 mm	2550 mm	1100 mm	500	4.753 €

Dimensiones

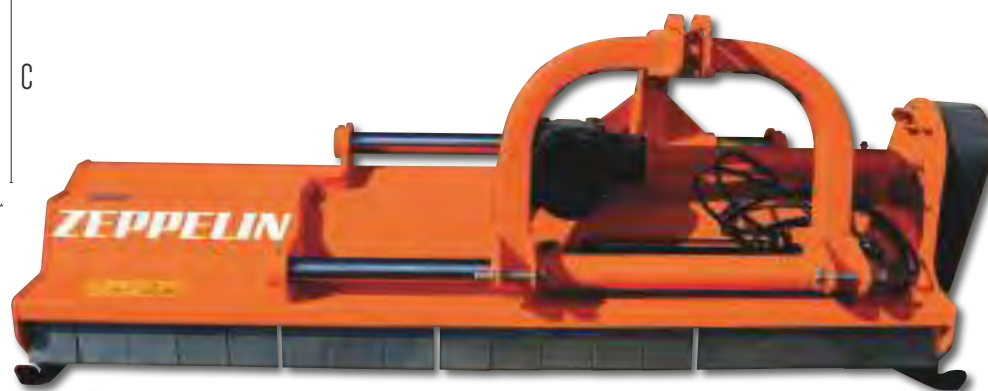
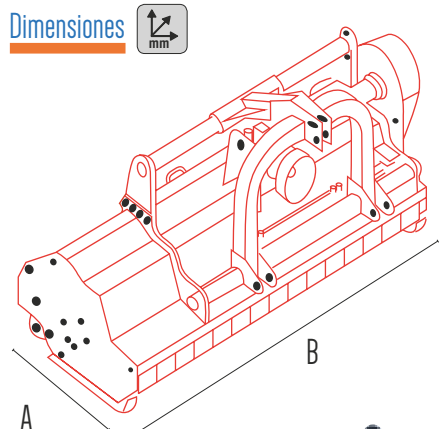

Grupo reforzado fundición.

Patines regulables en altura.

Ajuste de correas.

Correas 1ª calidad.

TRITURADORAS GRAN VOLUMEN DESP. CON GRUPO DESPLAZADO

Broyeur déportable à haute capacité / Triturador de grande volume com deslocamento hidráulico / High capacity side shift flail mower



DESPLAZABLE GRUPO DESPLAZADO PORTÓN REGULABLE Y RASTROJEROS

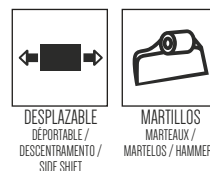

DETALLE TOTALMENTE DESPLAZADA

Trituradora Gran Volumen 2,2 m. desplazable. Grupo desplazado. HASTA 15 CM.

Triturador de grande volume e corta matos. *Recolhendo ancinhos e abertura traseira ajustável.* Ate 15 cm. / High capacity side shift flail mower and mower. *Collecting rakes and adjustable rear opening.* Up to 15 cm. / Broyeur déportable à haute capacité et gyrobroyeurs. *Tiges de ramassage et capot arrière.* Jusqu'à 15 cm.

- Proporciona un desplazamiento lateral máximo respecto a la toma de fuerza que permite un mayor alcance de triturado en espacios de difícil acceso o baja altura.
- Le déplacement latéral extrême par rapport à la boîte de vitesses permetre une plus grande portée de broyage dans les endroits d'accès difficile ou de faible hauteur.
- It provides an extreme lateral displacement relative to the gearbox, this allows a greater crushing reach in hard or low access areas.
- Proporciona um deslocamento lateral máximo em relação à tomada de força que permite um maior alcance de esmagamento em espaços de difícil acesso ou baixa altura.

Referencia	mm	Kg		Ø Rotor			PTO r/min	hp	A	B	C	Desplazamiento mm	€
ESDESPGVD220AP	2190	815	5	168	14	20	540	60/90	1200 mm	2350 mm	1100 mm	560	5.148 €

Dimensiones

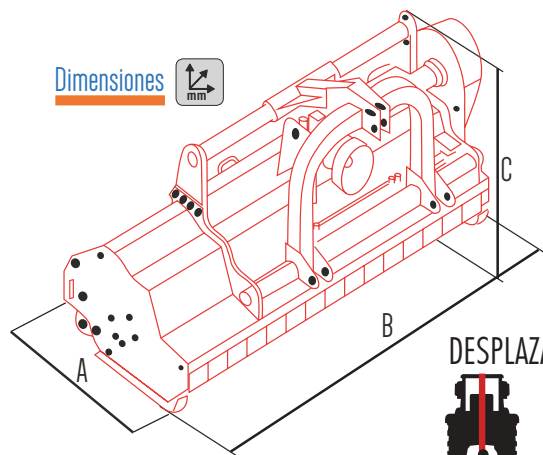

DESPLAZAMIENTO

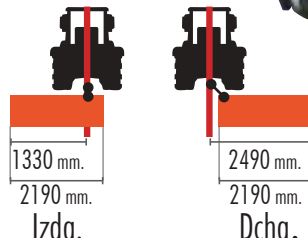

POSICIÓN RECOGIDA



Grupo desplazado.



Patines regulables en altura.



Trituradoras Gran Volumen Desp. con Grupo Desplazado

Broyeur déportable à haute capacité / Triturador de grande volume com deslocamento hidráulico / High capacity side shift flail mower



GRUPO DESPLAZADO

PORTÓN REGULABLE Y RASTROJEROS

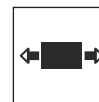

DESPLAZABLE DEPORTABLE / DESCENTRAMIENTO / SIDE SHIFT



MARTILLOS MARTEAUX / MARTELOS / HAMMERS



Trituradora Gran Volumen 2,2 m. con disco de 560 mm. HASTA 15 CM.

Broyeur déportable à haute capacité avec disque. Tiges de ramassage et capot arrière. Jusqu'à 15 cm. / Triturador de grande volume e corta matos com disco. Recolhendo ancinhos e abertura traseira ajustável e puas. Até 15 cm. / High capacity side shift flail mower with disc. Collecting rakes and adjustable rear opening. Up to 15 cm.

Permite un acabado perfecto del terreno mediante el disco de desbrozado lateral de dos cuchillas. Gracias a su sistema hidráulico y el brazo autoadaptable el disco lateral trabaja el borde de los frutales, olivos y lindes en perfecto acabado.

Le disque latéral à deux lames permet une finition parfaite. Grâce au système hydraulique et le bras auto-adaptable, le disque peut atteindre le bord des arbres fruitiers, des oliviers et les bordures des champs.

This lateral disc with two blades allows a cutting with perfect finishing. Thanks to the hydraulic system and self-adaptable arm, the disc can reach the edge of fruit and olive trees, and field borders.

Permite um perfeito acabamento do terreno por meio do disco de corte lateral de duas lâminas. Graças ao seu sistema hidráulico e ao braço auto-adaptável, o disco lateral trabalha na borda das árvores frutíferas, oliveiras e bordas em perfeito acabamento.

Referencia	mm	Kg	Ø	Rotor	PTO	hp	A	B	C	Desplazamiento	€		
ESDESPGVDD220AP	2190	815+60	5	168	14	20	540	60/90	1200 mm	2350 mm	1100 mm	560	5.604 €

Dimensiones

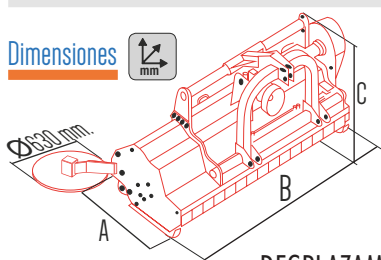

KIT Disco y latiguillos hidráulicos

Referencia	€
ES71639	895 €

DESPLAZAMIENTO

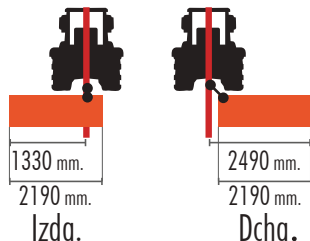

Grupo Desplazado

Disco desbrozador con dos cuchillas

Sistema de amortiguación del disco

TRITURADORAS MULTIFUNCIONAL LIGERAS

Broyeur d'accotement / Trituradores multifuncionais / Offset flail mower



MULTIFUNCIONAL

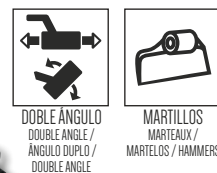

Trituradora multifuncional ligera. HASTA 5 CM.

Broyeur multifonctionnel léger. Jusqu'à 5 cm. / Triturador multifuncional ligeiro. Até 5 cm. / Multifunctional light flail mower. Up to 5 cm.

- Desbrozadora con brazo hidráulico para mantenimiento de bordes, límites del campo y arcenes. Resto de poda de hasta 5 cm de diámetro.
- Broyeur avec bras hydraulique pour l'entretien des bords et des limites de terrain. Restes d'élagage jusqu'à 5 cm de diamètre.

- Flail mower with hydraulic arm to maintain the edges and field boundaries. Pruning up to 5 cm diameter.
- Com braço hidráulico para manutenção de bermas, limites de campos e estradas. Outras podas até 5 cm de diâmetro.

Referencia	Kg						A	B	C	D	E	PTO r/min		€
ESDESB1050	230	90°	53°	1000	3	16	1730	1510	1190	330	1250	540	25-85	2.299 €
ESDESB1250	250	90°	53°	1200	3	20	1930	1510	1390	330	1250	540	25-95	2.499 €

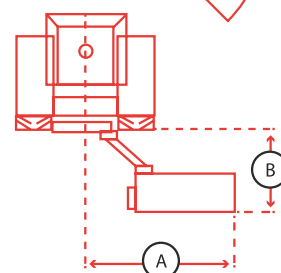
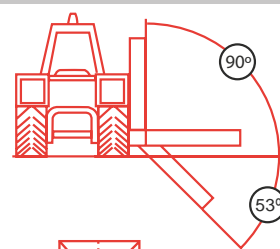

Dimensiones
Alto 1100 mm.

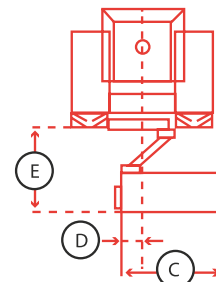

2 hidráulicos para giro lateral y eje.



Correas 1ª calidad.

TRITURADORAS MULTIFUNCIONAL

Broyeur d'accotement / Trituradores / Offset flail mower



MULTIFUNCIONAL REFORZADAS

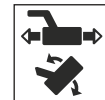

DOBLE ÁNGULO
DOUBLE ANGLE /
ÁNGULO DUPLIO /
DOUBLE ANGLE



MARTILLOS
MARTEAUX /
MARTELOS / HAMMERS



Ver video Canal Zeppelin Maquinaria

Trituradora multifuncional reforzada. HASTA 14 CM.

Broyeur multifonctionnel renforcé. Jusqu'à 14 cm. / Triturador multifuncional reforçado. Até 14 cm. / Reinforced multifunctional flail mower. Up to 14 cm.

Desbrozadora con brazo hidráulico para mantenimiento de bordes, límites del campo y arceras. Serie R: Chapa reforzada y Apertura regulable en portón.

Flail mower with hydraulic arm to maintain the edges and field boundaries. R series: Reinforced plates and adjustable rear opening.

Broyeur avec le bras hydraulique pour l'entretien des bords et des limites de terrain. Série R: Tôle renforcée et capot arrière ouvrable.

Com braço hidráulico para manutenção de bermas, limites de campos e estradas. Série AP Folha reforçada e abertura ajustável na porta traseira, com puas.

Hasta 1.80m

Referencia	Kg	↙	↘	↔ mm	📍	📁	A	B	C	D	E	PTO t/min	🚜 hp	€
ESDESB1400CR	490	90°	53°	1380	3	12	2410	1750	1450	475	1623	540	45-85	3.178 €
*ESDESB1400R	520	90°	53°	1380	3	12	2410	1750	1450	475	1623	540	45-85	3.301 €
ESDESB1600CR	540	90°	53°	1580	3	14	2610	1750	1650	475	1623	540	60-95	3.370 €
*ESDESB1600R	678	90°	53°	1580	3	14	2610	1750	1650	475	1623	540	60-95	3.492 €
ESDESB1800CR	590	90°	53°	1780	3	16	2810	1750	1850	475	1623	540	70-110	3.583 €
*ESDESB1800R	710	90°	53°	1780	3	16	2810	1750	1850	475	1623	540	70-110	3.703 €

*APERTURA / CAPOT ARRIÈRE OUVRABLE / COM ABERTURA / REAR OPENING

Dimensiones

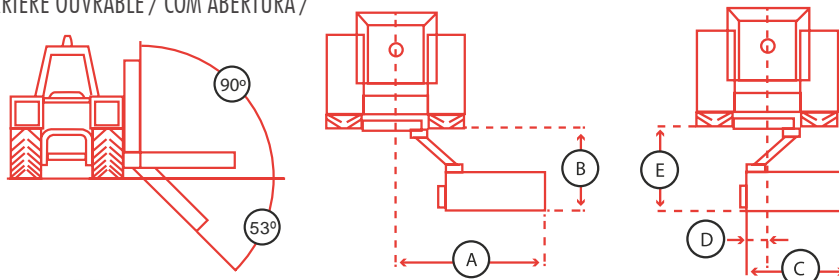

Martillos Modelo REFORZADO.



Refuerzo lateral del rotor.



Tres correas 1ª calidad.



Patines regulables altura.



Grupo reforzado con protección.

TRITURADORAS MULTIFUNCIONAL REFORZADAS

Broyeur d'accotement / Trituradores / Offset flail mower



MULTIFUNCIONAL

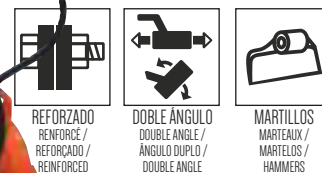

ESDESB2450AP



ESDESB2000
ESDESB2200

REGULABLE DE 53° A 90°

REFUERZOS EN ESTRUCTURA Y GRUPO mod.AP

Trituradora multifuncional reforzada. HASTA 12 CM.

Reinforced multifunctional flail mower. Jusqu'à 12 cm. / Triturador multifuncional reforçado. Até 12 cm. / Broyeur multifonctionnel renforcé. Up to 12 cm.

ES Desbrozadora con brazo hidráulico para mantenimiento de bordes, límites de campo y arceles. Serie AP Chapa reforzada y Apertura regulable en portón.
FR Broyeur avec bras hydraulique pour l'entretien des bords et des limites de terrain. Série AP: Tiges de ramassage et capot arrière ouvrable.

GB Flail mower with hydraulic arm to maintain the edges and field boundaries. AP series: Collecting rakes and adjustable rear opening.
PT Com braço hidráulico para manutenção de bermas de campos e estradas. Série AP: Folha reforçada e abertura ajustável na porta traseira.

De 2 a 2.45m

Referencia	Kg						A	B	C	D	E	PTO r/min		€
ESDESB2000	640	90°	53°	1980	4	18	3010	1750	2050	475	1623	540	70-110	3.820 €
*ESDESB2000AP	720	90°	65°	1980	4	18	3010	1750	2050	475	1623	540	70-110	3.975 €
ESDESB2200	690	90°	53°	2180	4	20	3210	1750	2250	475	1623	540	70-110	4.035 €
*ESDESB2200AP	760	90°	65°	2180	4	20	3210	1750	2250	475	1623	540	70-110	4.180 €
*ESDESB2450AP	928	90°	55°	2450	5	26	3358	1998	2450	475	1650	540	110-120	4.570 €

*CON RASTROJERO Y PORTÓN / AVEC TIGES DE RAMASSAGE ET CAPOT ARRIERE / COM DENTES E PORTA / WITH COLLECTING RAKES AND REAR OPENING

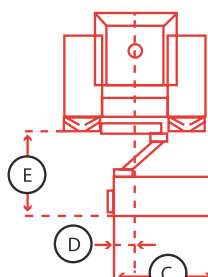
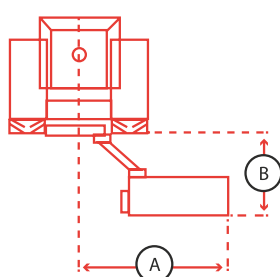
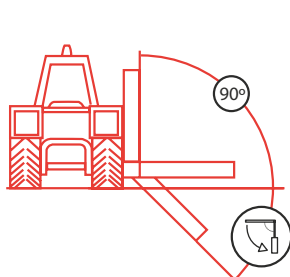

Patines regulables en altura.



Grupo reforzado con protección.

DESBOZADORA BRAZO LATERAL HIDRÁULICO

Épareuse hydraulique / Triturador de brazo lateral hidráulico / Hydraulic Hedge Cutter

LOIRE



Cuchillas



ESDESB800HZ



ESDESB1000HZ



Desbrozadora brazo lateral hidráulico

Épareuse avec bras hydraulique. / Triturador de brazo lateral hidráulico. / Hedge Cutter with hydraulic arm.

🇪🇸 Ideal para cunetas, riberas y zonas inclinadas.

Ajuste de altura y ángulo. Capacidad de aceite: 55 l
Enganche semi-automático al cortasetos.

🇫🇷 Idéal pour l'entretien des routes, des bords et les limites de terrain.

Hauteur et angle réglables. Capacité d'huile 55 l
Attelage semi-automatique au taille-haie.

🇬🇧 Ideal for the maintenance of the edges and field boundaries, banks and road-sides.

Height and angle adjustment. Oil tank capacity 55 l
Semi-automatic hedge cutter hitch.

🇪🇸 Ideal para represas, rios e áreas inclinadas.

Ajuste de altura e ângulo. Capacidade de óleo: 55 l
Engate 3º ponto.

Referencia	mm	Kg	Ø Rotor	hp	PTO r/min	A	B	C	α	β	Y	€	
ESDESB800HZ	800	285	32	78	18-50	540	2700 mm	1300 mm	2400 mm	176°	116°	1230 mm	4.980 €
ESDESB1000HZ	1000	300	40	78	25-40	540	2900 mm	1300 mm	3200 mm	176°	116°	1230 mm	5.180 €

Dimensiones

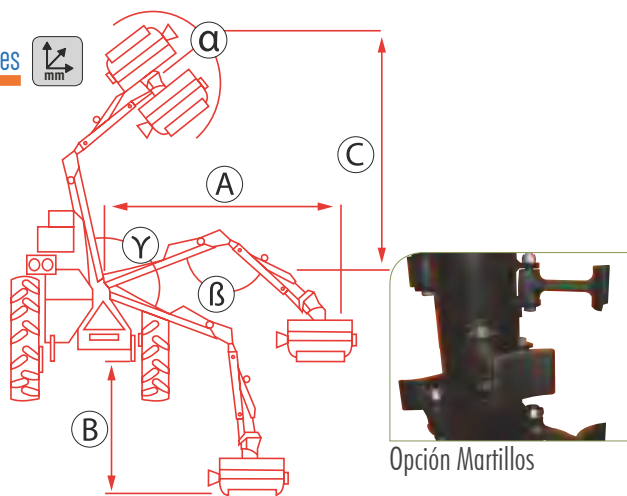

Opción Martillos



Referencia	mm	Kg	€
ES70843	130 cm.	50 kg.	840 €
ES71506	145 cm.	55 kg.	890 €
ES71527	165 cm.	61 kg.	940 €

Barra de cuchillas con motor hidráulico.

Taille-haie avec moteur hydraulique.

Trimmer with hydraulic engine.

Para modelos
ESDESB800HZ
ESDESB1000HZ

DESbrozadora 1.3 BRAZO LATERAL HIDRÁULICO

Épareuse hydraulique / Triturador de brazo lateral hidráulico / Hydraulic Hedge Cutter



CABEZAL DE 1,30 M.



MARTILLOS
MARTEAUX /
MARTELOS / HAMMERS



Modelo con radiador.



Martillos



Opción Cuchillas

Desbrozadora brazo lateral hidráulico

Épareuse avec bras hydraulique. / Triturador de brazo lateral hidráulico. / Hedge Cutter with hydraulic arm.



ES Sistema flotante de autonivelación al terreno. Funcionamiento bidireccional del cabezal triturador. Distribuidor con palanca de antiinversión. Telemandos a distancias flexibles. Sistema de doble cuchilla. Depósito aceite 280L.

FR Système flottant auto-nivelant au terrain. Le rotor de la tête tourne dans les 2 sens. Distributeur avec levier anti-inversion. Commande par téléflexible. Système à double lame. Dépôt d'huile 280L.

UK Self-leveling floating system on the ground. Head rotor turns in both directions. Distributor with anti-inversion lever. Teleflexible control. Double blade system. Oil tank 280 L.

PT Sistema de cabeça flutuante com autonivelamento. Operação bidireccional da cabeça. Distribuidor com alavanca anti-inversão. Telecomandos a distâncias flexíveis. Sistema de facas duplas. Depósito óleo 280L.

Referencia	mm	Kg	ØRotor	hp	PTO r/min	A	B	C	D	E	€	
ESDES1300HHDZ	1300	1.100	32	78	90	540	2300 mm	6200 mm	2100 mm	6200 mm	5200 mm	9.530 €
*ESDES1300HHDZR	Opción con RADIADOR										10.370 €	



Funcionamiento bidireccional del cabezal triturador.

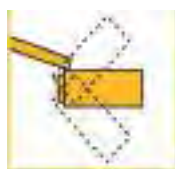

Sistema flotante de autonivelación al terreno.

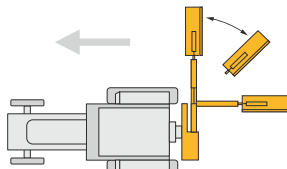

Rotación Hidráulica con dispositivo de seguridad.

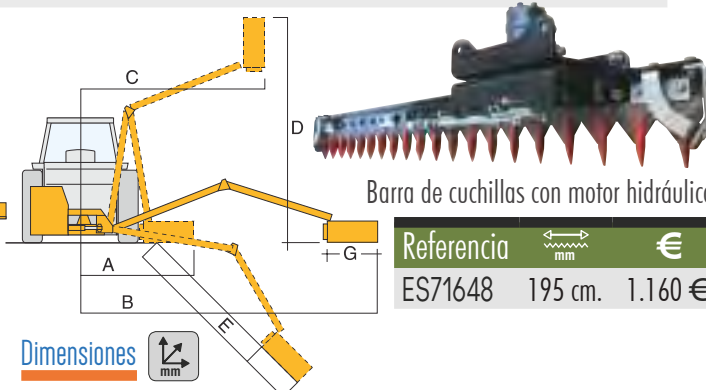

Barra de cuchillas con motor hidráulico.

Referencia	mm	€
ES71648	195 cm.	1.160 €

Dimensiones

TRITURADORAS REVERSIBLES ESPECIAL VIÑA Y OLIVAR

Broyeur réversible lourd spécial pour le vignoble et oliveraie / Triturador reversível especial vinha e olival / Reversible Heavy Flail mower especial vineyard and olive plantation

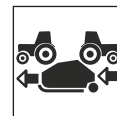

REVERSIBLE
RÉVERSIBLE /
REVERSIVEL /
REVERSIBLE /

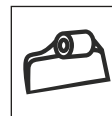

MARTILLOS
MARTEAUX /
MARTELOS /
HAMMERS /

RAMAS
HASTA 16 CM.

Reversible para restos de poda. Especial Viña y Olivar. HASTA 16 CM.

Broyeur réversible lourd spécial pour les vignobles et les oliveraies. Jusqu'à 16 cm. / Triturador reversível especialmente adequado para olival e pomares e ramos grossos. Até 16 cm. / Reversible Heavy Flail mower special for vineyards and olive groves. To 16 cm.

Púas de recogida y rodillo alimentador para el pretriturado con regulador por motor hidráulico.

Avec dents de ramassage et rouleau d'alimentation pour le pré-broyage avec régulateur par système hydraulique.

With picking tines and feeding roller for pre-crushing with regulator by hydraulic system.

Púas e rolo de alimentação para pré trituração com regulador por motor hidráulico.

Referencia	Kg	mm		PTO r/min	hp	A	B	C	€
ESTOV130MZ	1.254	1300	16	540	50-100	1280 mm	1750 mm	1600 mm	4.850 €
ESTOV150MZ	1.353	1500	18	540	50-100	1280 mm	1950 mm	1600 mm	5.400 €
ESTOV180MZ	1.430	1800	22	540	80-100	1280 mm	2250 mm	1600 mm	6.050 €



KIT RUEDA GOMA
Roues/Rodas/Wheels
OPCIÓN

Referencia	€
ESTOPRAMKITR	406 €



Grupo reforzado reversible.



Alimentador y púas



Aletas laterales recogedoras



Alimentación hidráulica



Rejilla trasera

TRITURADORAS REVERSIBLES

Broyeur réversible lourde / Triturador reversível / Reversible Heavy Flail mower



Doble alimentador regulado por motor hidráulico.

REFORZADO RENFORCÉ / REFORÇADO / REINFORCED	REVERSIBLE RÉVERSIBLE / REVERSIVEL / REVERSIBLE	MARTILLOS MARTEAUX / MARTELOS / HAMMERS

Reversible para restos de poda. Especial Viña y Olivar. HASTA 16 CM.

Broyeur réversible lourd spécial pour les vignobles et les oliveraies. Jusqu'à 16 cm. / Triturador reversível especialmente adequado para olival e pomares e ramos grossos. Ate 16 cm. / Reversible Heavy Flail mower special for vineyards and olive groves. Up to 16 cm.

Regulación velocidad alimentador. Martillos reforzados. Chasis reforzado. Protección seguridad normativa CE. Tensor de cadenas y tensor de correas.

Régulation de la vitesse de rouleau d'alimentation. Marteaux renforcés. Châssis renforcé. Protection sécurité norme CE. Tendeurs des chaînes et des courroies.

Regulation of feeding roller speed. Reinforced hammers. Reinforced chassis. Protection according CE safety regulation. Chain and transmission belt tensioners.

Regulação da velocidade do alimentador. Martelos Reforçados. Chassis reforçado. Proteção de segurança regulamentar do CE. Regulador de Tensor da corrente e tensor da correia.

Referencia	Kg	mm	mm	PTO r/min	hp	A	B	C	€
ESTOPRAM13MZ	840	1300	16	540	75	1213 mm	1654 mm	1472mm	7.592 €
ESTOPRAM15MZ	1.300	1500	18	540	90	1308 mm	1866 mm	1470 mm	7.912 €
ESTOPRAM16MZ	1.350	1600	18	540	90	1308 mm	1966 mm	1470 mm	8.243 €
ESTOPRAM18MZ	1.458	1800	22	540	100	1308 mm	2150 mm	1550 mm	8.400 €

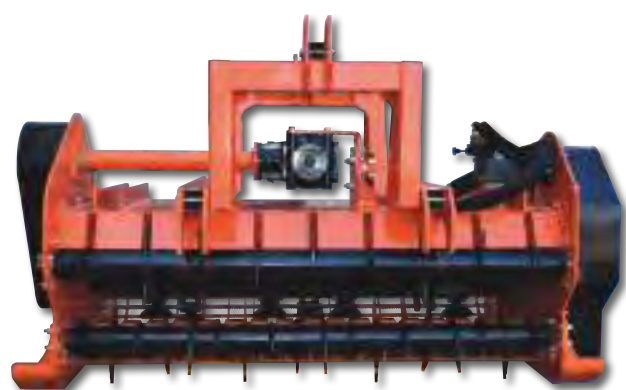

KIT RUEDA GOMA
Roues/Rodas/Wheels
OPCIÓN

Referencia	€
ESTOPRAMKITR	406 €

Dimensiones

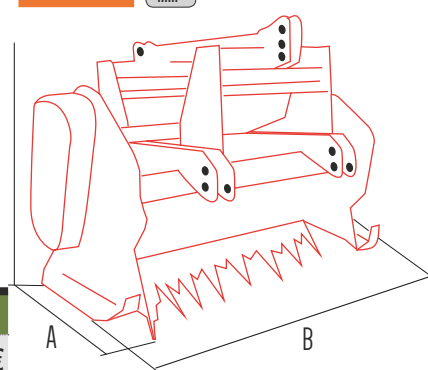

Grupo reforzado reversible.



Doble Alimentador.



Regulación hidráulica.



Ajuste de correas.



Cinco correas 1º calidad.

ROTOVATORS LIGEROS

Fraises arrières légère / Fresas ligeira / Compact Tillers



Rotovator gama ligera

Fraisesarrière légères / Fresas gama ligeira / Compact tillers

Alerón trasero de seguridad ajustable. Patines regulables en altura.
| Transmisión por cadena. Grupo reforzado.

Adjustable opening safety tailgate. Height adjustable skids.
| Chain transmission. Reinforced gearbox.

Tôle arrière de sécurité réglable. Talons réglables en hauteur.
| Transmission à chaîne. Boîtier d'engrenages renforcé.

Porta traseira de segurança ajustável. Patins ajustáveis em altura.
| Transmissão por correntes. Grupo reforçado.

Gama Ligera

Referencia	mm	Kg	mm			PTO r/min	hp	A	B	C	€
ESROT095ZV	900	175	90	16	4	540	12-20	880 mm	970 mm	730 mm	1.310 €
ESROT105ZV	1000	195	90	20	5	540	15-22	880 mm	1070 mm	730 mm	1.370 €
ESROT125ZV	1200	235	90	28	7	540	18-22	880 mm	1270 mm	730 mm	1.420 €
ESROT135ZV	1300	255	90	28	7	540	18-22	880 mm	1370 mm	730 mm	1.430 €

Dimensiones

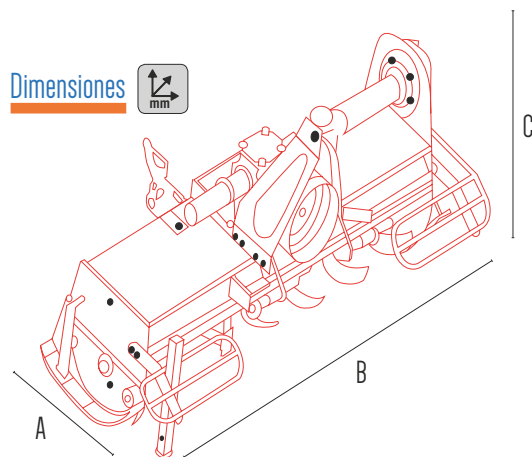

C

B

A



Grupo reforzado fundición.

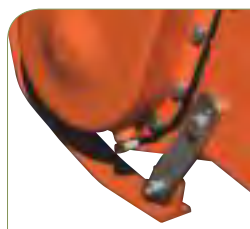

Patín regulable en altura.



Detalle grupo cuchillas.

ROTOVATORS REFORZADOS

Fraises arrières renforcée/ Fresas reforçada / Reinforced Tillers

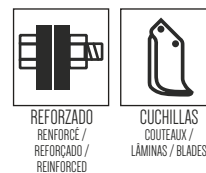

Rotovator gama reforzada

Fraise arrière renforcée / Fresas gama reforçada / Reinforced Tillers

Alerón trasero de seguridad ajustable. Patines regulables en altura. Transmisión por engranajes. Grupo reforzado.

Adjustable opening safety tailgate. Height adjustable skids. Gears transmission. Reinforced gearbox.

Tôle arrière de sécurité réglable. Talons réglables en hauteur. Transmission à engrenages. Boîtier d'engrenages renforcé.

Puerta trasera de segurança ajustável. Patins ajustáveis em altura. Transmissão por engrenagens. Grupo reforçado.

Gama Reforzada

Referencia	Kg	mm	mm	mm	Interior + Lateral	PTO r/min	hp	A	B	C	€
ESROT105Z	265	1050	140	30	4 + 2 = 6	540	16-20	950 mm.	1250 mm	1000 mm	1.700 €
ESROT125Z	327	1250	140	36	5 + 2 = 7	540	16-20	950 mm.	1450 mm	1000 mm	1.750 €
ESROT135Z	348	1350	140	36	5 + 2 = 7	540	25-30	950 mm.	1550 mm	1000 mm	1.770 €
ESROT150Z	359	1500	140	42	6 + 2 = 8	540	30-50	950 mm.	1750 mm	1000 mm	1.945 €
ESROT170Z	373	1700	140	48	7 + 2 = 9	540	40-70	950 mm.	1950 mm.	1000 mm	2.035 €
ESROT180Z	380	1800	140	48	7 + 2 = 9	540	40-75	950 mm.	2050 mm	1000 mm	2.060 €

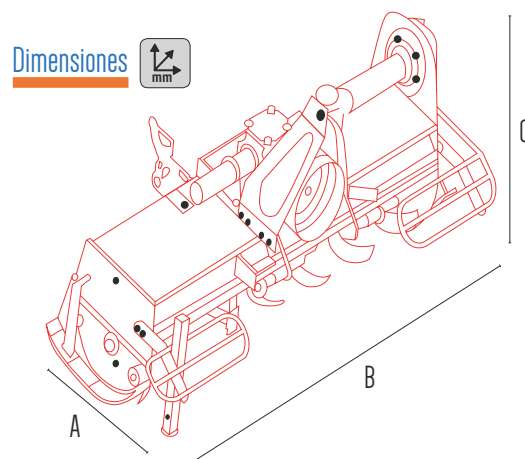

ROTOVATORS CON DESPLAZAMIENTO

Fraises arrières déportable / Fresas com deslocamento / Side shift Tillers



Rotovator con desplazamiento

Fraise arrière déportable. / Fresas com deslocamento. / Side shift tiller.

Preparación del terreno para cultivo mediante incorporación de residuos vegetales y desterronador.
Desplazamiento lateral para llegar a las zonas más inaccesibles.
Desplazamiento horizontal hidráulico.

Préparation du sol pour la culture, par l'incorporation de restes végétaux, et émotteuse.
Déplacement latéral horizontal hydraulique pour atteindre les zones les plus inaccessibles.

Soil preparation for cultivation through the incorporation of vegetal waste, and soil crumbling.
Hydraulic horizontal lateral displacement to reach the most inaccessible areas.

Preparação do terreno para cultivo, incorporando resíduos de plantas.
Movimento lateral para alcançar as áreas mais inacessíveis.
Deslocamento horizontal hidráulico.

Con desplazamiento

Referencia	mm	mm	mm	Kg	mm		hp	A	B	C	€
ESROTDESP150Z	1500	120	480	365	1950	42	30-50	720	1580	880	2.431 €
ESROTDESP180Z	1800	120	480	400	2250	48	30-50	720	1880	880	2.567 €

Dimensiones

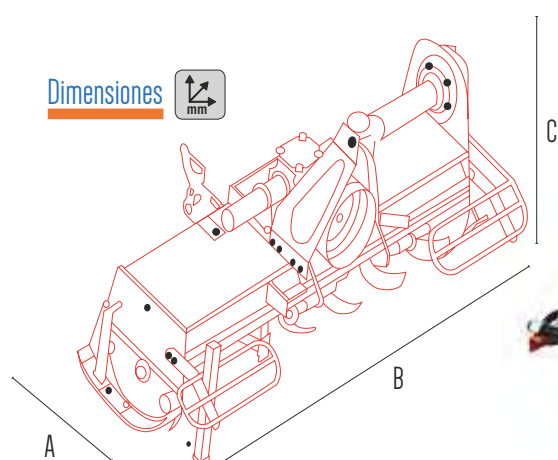

Grupo reforzado fundición. Patín regulable en altura. Detalle grupo cuchillas.

ROTOVATORS SUPER REFORZADOS

Fraises arrières super renforcé / Fresas super reforçada / Super reinforced Tillers



REFORZADO
RENFORCE
REFORÇADO
REINFORCED



CUCHILLAS
COUTEAUX
LÂMINAS / BLADES



Ver vídeo Canal Zeppelin Maquinaria

Rotovator gama super reforzada

Fraises arrière super renforcé / Fresas gama super reforçada / Super Reinforced Tillers

ES Apero para la preparación de lecho de siembra aireando la tierra y permitiendo que la plantación germine mejor.
Incorpora los restos de la plantación anterior como nutriente del terreno.
Las cuchillas giran sobre el eje para romper los terrones y tierra apelmazada.

UK Machinery to prepare the soil for cultivation, aerating the ground and allowing a better germination of the plantation.
It allows adding the waste of the previous plantation as a nutrient for the soil.
The blades turn on the rotor to break the soil clods.

FR Machine pour la préparation du sol pour la culture, l'aération du terrain et permettant à la plantation de mieux germer.
Elle permet d'ajouter le reste de la plantation précédente comme nutriment pour la terre. Les couteaux tournent sur le rotor pour briser les mottes de terre.

PT Máquina para a preparação da sementeira arejando a terra e permitindo que a plantação germine melhor.
Incorpora os restos da plantação anterior como nutriente do solo.
As facas giram no eixo para quebrar os pedaços de terra.

Gama Super Reforzada

Referencia	Kg	mm	mm			PTO r/min	hp	A	B	C	€
ESROT180MZ	455	1800	160	48	8	540	45-55	1030 mm	2000 mm	1145 mm	3.071 €
ESROT200Z	483	2000	220	54	9	540	50-60	1030 mm	2170 mm	1145 mm	3.092 €
ESROT220Z	503	2200	220	60	10	540	60-70	1030 mm	2370 mm	1145 mm	3.307 €
ESROT230Z	517	2300	220	60	10	540	70-80	1030 mm	2470 mm	1145 mm	3.439 €

Dimensiones

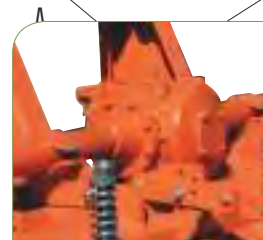
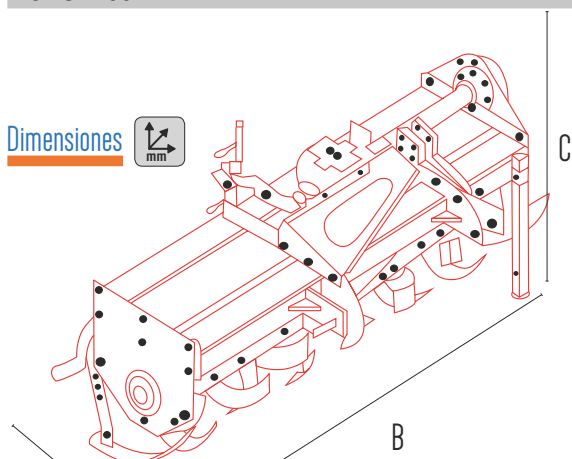

Grupo reforzado fundición.



Patín regulable en altura.



Detalle grupo cuchillas.

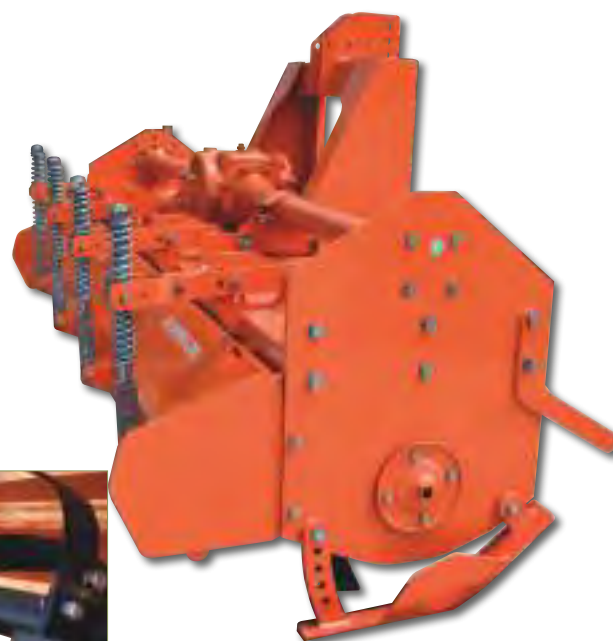

ROTOVATORS REFORZADOS 4 VELOCIDADES

Fraises arrières renforcées 4 vitesses / Fresas reforçada 4 velocidades / 4 Speed Reinforced Tillers

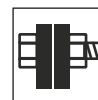

REFORZADO
RENFORCE
REFORÇADO
REINFORCED



CUCHILLAS
COUPEAUX
LÂMINAS / BLADES



Rotovator gama reforzada 4 velocidades

Fraise arrière renforcée 4 vitesses / Fresa reforçada de 4 velocidades / 4-speed reinforced tiller

Preparación del terreno para la siembra.

Con 4 velocidades de trabajo permite un volumen de picado y triturado adecuado a diferente grosor.

Toma de fuerza 1" 3/4 Z6. CARDAN NO INCLUIDO.

Préparation du sol pour la culture.

Boîte 4 vitesses, permet un volume de hachage et de broyage adapté à différentes épaisseurs.

PTO 1" 3/4 Z6, cardan NON INCLUS.

Soil preparation for cultivation. 4-speed gearbox, it allows a chopping and trituration volume adapted to different thicknesses. PTO 1" 3/4 Z6, cardan NOT INCLUDED.

Preparação do terreno para plantação.

Com 4 velocidades de trabalho permite diferentes formas de preparação do terreno.

PTO 1" 3/4 Z6. CARDAN NÃO INCLUIDO.

Referencia	Kg	← mm	↑ mm			PTO r/min		A	B	C	€
ESROT200Z4V	714	2000	170	54	9	540	80	1070 mm	2290 mm	1200 mm	3.885 €
ESROT230Z4V	755	2300	170	60	10	540	120	1070 mm	2490 mm	1200 mm	4.148 €
ESROT250Z4V	805	2500	170	66	11	540	140	1070 mm	2690 mm	1200 mm	4.305 €

Dimensiones

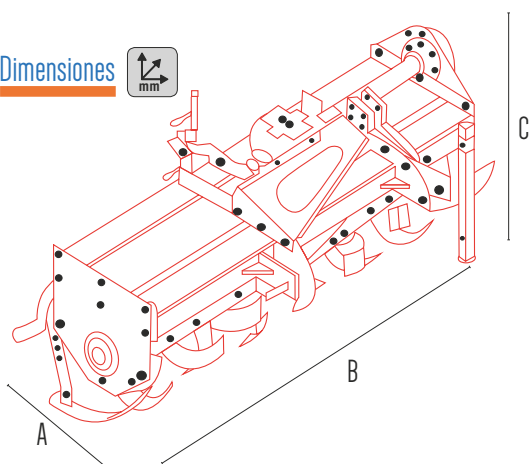

Grupo reforzado 4V.



Patín regulable en altura.



Detalle grupo cuchillas.

DESBROZADORA LIGERA

Gyrobroyeurs / Capinadeiras - corta matos / Topper mowers

Desbrozadora Especial microtractor Cuchillas

Gyrobroyeur à lames / Capinadeiras - corta matos com laminas reforçadas / Topper mower with blades

Referencia	mm	mm	PTO r/min	hp	Kg	€
ESDTM090Z	1000x980	900	540	18-35	80	709 €



CUCHILLAS
COUTEAUX /
LÁMINAS / BLADES

DESBROZADORAS REFORZADAS

Gyrobroyeur / Capinadeiras / Topper mower

ARENA

REFORZADA



ESDTM170REFCZ

Desbrozadora Reforzada Cadenas

Gyrobroyeur à chaînes / Capinadeiras - corta matos com correntes reforçadas / Topper mower with chains



Referencia	mm	mm	PTO r/min	hp	Kg	€
ESDTM090REFCZ	1000x900	900	540	18-35	105	907 €
ESDTM120REFCZ	1250x1200	1150	540	25-40	170	1.160 €
ESDTM150REFCZ	1550x1500	1450	540	25-40	270	1.284 €
ESDTM160REFCZ	1650x1600	1565	540	25-40	310	1.620 €
ESDTM170REFCZ	1750x1700	1650	540	30-50	325	1.827 €
ESDTM200REFCZ	2100x2000	1980	540	60-100	360	2.038 €



REFORZADO
RENFORCE / REFORCA-
DO / REINFORCED



CADENAS
CHAÎNES
/ CORRETES / CHAINS

Desbrozadora Reforzada Cuchillas

Gyrobroyeur à lames / Capinadeiras - corta matos com laminas reforçadas / Topper mower with blades



Referencia	mm	mm	PTO r/min	hp	Kg	€
ESDTM090REFZ	1000x900	900	540	18-35	105	825 €
ESDTM120REFZ	1250x1200	1150	540	25-40	170	1.055 €
ESDTM150REFZ	1550x1500	1450	540	25-40	270	1.168 €
ESDTM160REFZ	1650x1600	1565	540	25-40	310	1.472 €
ESDTM170REFZ	1750x1700	1650	540	30-50	325	1.662 €
ESDTM200REFZ	2100x2000	1980	540	60-100	360	1.854 €



REFORZADO
RENFORCE /
REFORCADO /
REINFORCED



CUCHILLAS
COUTEAUX /
LÁMINAS / BLADES



Ver video Canal
Zeppelin
Maquinaria



Grupo reforzado.



Patines regulables en altura.



3er punto reforzado con cadena.



Chapa reforzada.

DESBROZADORAS CON DISCO LATERAL

Tondeuse de finition / Capinadeiras- corta matos / Finishing mowers

DESPLAZAMIENTO HIDRÁULICO

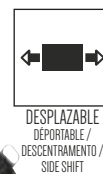

DESPLAZABLE
DEPORTABLE /
DESCENTRAMENTO /
SIDE SHIFT



CUCHILLAS
COUTEAUX /
LÁMINAS / BLADES



MODELO 2,5 m.
con 2 DISCOS



MODELO 1,8 m.
con 1 DISCO



MODELO 1,5 m. con 2 DISCOS

Desbrozadora desplazable montada en la parte trasera, con diseño extraplano, adecuado para trabajar en viñedos y huertos. Equipo estándar: anclaje de 3 puntos, Cat I (mod.250 Cat II). Altura de corte ajustable, ruedas delanteras giratorias y deflector de cadena delantero.

Offset mower with extra flat design, for maintaining meadows, vineyards and orchards. Standard equipment: 3-point linkage (150/180 model Cat. I)(250 model Cat. II). Adjustable cutting height, rotating front wheels, protecting front chain, rear roller.

Tondeuse arrière avec déplacement latéral, design extra plat, pour l'entretien des prairies, des vignes et des vergers. Equipement standard: attelage à 3 points (modèle 150/180, cat. I) (250, cat. II). Hauteur de coupe réglable, roues avant rotatives, chaîne de protection avant, rouleau arrière.

Triturador móvel montado na parte traseira, com design extra-plano, adequado para trabalhar em vinhas e pomares. Equipamento de série: âncora de 3 pontos, Cat I (mod.250 Cat II). Altura de corte ajustável, rodas dianteiras fixas, deflector da corrente dianteira, rolo traseiro, lâminas articuladas, veio de transmissão.

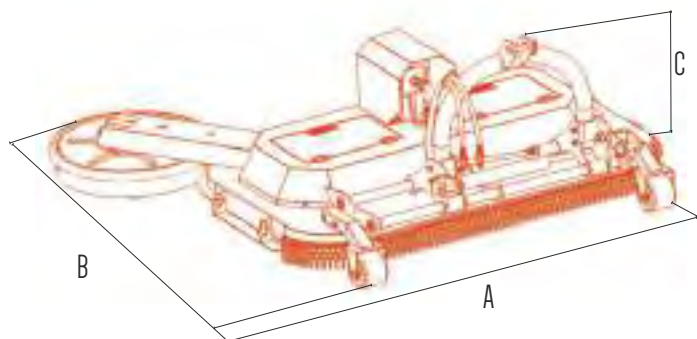

Disco lateral Ø 650 mm.
Cuchillas:
Espesor 8 mm.
Longitud 107 mm
Anchura 60 mm.



Disco lateral con dos cuchillas



3 Discos de 2 cuchillas: Espesor 8 mm. Longitud 107 mm.
Anchura 60 mm.



Tapas superiores de acceso.



Rodillo ajustable.
3 posiciones.



Desplazamiento hidráulico.

Referencia	AxBxC mm	mm total	mm plegada / folded	mm		Desplazamiento	PTO r/min			Kg	€
ESDES150DISC1Z	1900x1680x740	1450+550	1450+100	20/40/60	3+1	540	540	25-50	4	312	2.365 €
ESDES150DISC2Z	2220x1680x740	1450+1100	1450+700	20/40/60	3+2	540	540	25-50	5	384	3.737 €
ESDES180DISC1Z	2200x1680x740	1750+450	1750+100	20/40/60	3+1	540	540	30-50	4	330	2.590 €
ESDES250DISC2Z	3520x1880x950	2450+700	2450+110	40/60/80	3+2	464	540	70-100	2	550	4.436 €

TRITURADORA HIDRAULICA PARA CARGADORA DE RUEDAS

Broyeur hydraulique poussé pour valet de ferme / Triturador hidráulico para carregadores / Hydraulic flail mower for wheel loaders

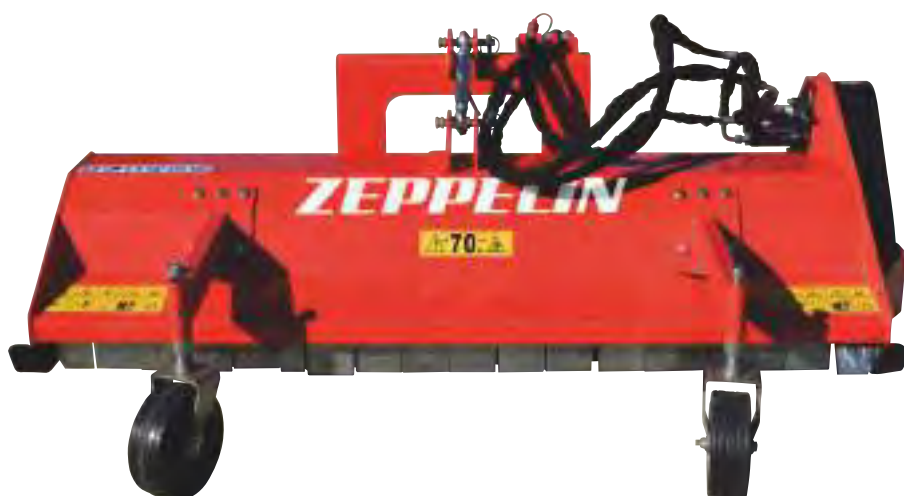

MARTILLOS
HAMMERS /
MARTEAUX /
MARTELOS

Trituradora frontal con enganche tipo EURO B para hierba y restos de poda .

Front mower with EURO B hitch for grass and pruning.

Broyeur avant avec le cadre EURO B pour valet de ferme pour l'herbe et les restes d'élagage.

Capinadeira com engate tipo EURO B para erva e resto de poda.

Referencia	mm	mm			Kg	€
ESTRHDCAR105Z	1180x1170x670	1050	16	3	240	2.504 €
ESTRHDCAR125Z	1180x1370x670	1250	20	3	260	2.790 €
ESTRHDCAR155Z	1180x1670x670	1550	24	3	288	2.981 €
ESTRHDCAR175Z	1180x1870x670	1750	28	3	308	3.220 €



EURO B (Acoples: Anchura 60 cm. Altura 30 cm.)

DESBROZADORA HIDRAULICA PARA CARGADORA DE RUEDAS

Tondeuse hydraulique poussée pour valet de ferme / Capinadeira hidráulica para carregadores / Hydraulic topper mower for wheel loaders



ESDTMHDCAR120Z

Enganche EURO B
Acoples: Anchura 60 cm. Altura 30 cm.



CUCHILLAS
BLADES / COUTEAUX
LÂMINAS

Desbrozadora de cuchillas frontal con enganche tipo EURO B para hierba y espacios verdes.

Front topper mower with blades with EURO B hitch for grass and green spaces.

Tondeuse avant avec le cadre EURO B pour l'herbe et des espaces verts.

Capinadeira com engate tipo EURO B para erva e espaços verdes.

Referencia	mm	mm	PTO r/min	Kg	€
ESDTMHDCAR120Z	1110x1230x650	1200	540	230	2.337 €
ESDTMHDCAR150Z	1110x1530x650	1500	540	245	2.639 €

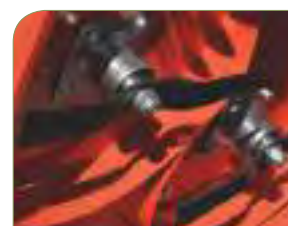

Bomba hidráulica de 50 l/min. Tres pares de cuchillas.

DESBROZADORA HIDRAULICA DE DISCO

Tondeuse hydraulique de bras à disque / Capinadeira de disco / Hydraulic finishing disc mower



BOMBA HIDRÁULICA 30 L/MIN

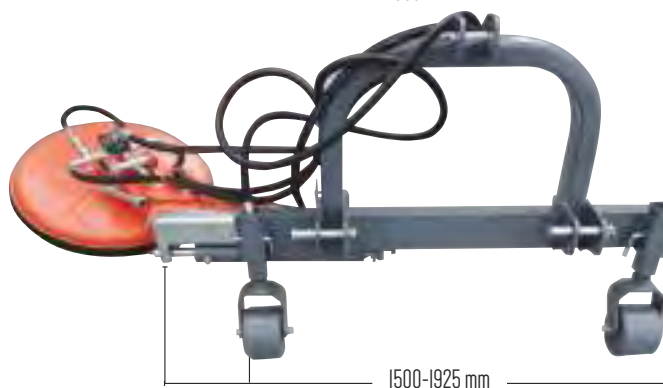
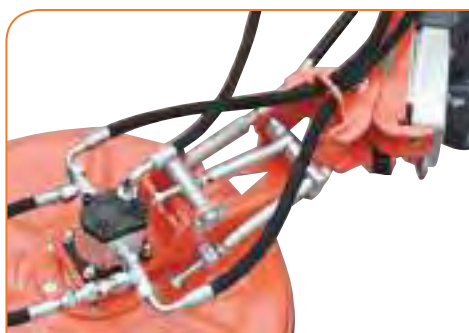

Brazo desbrozador con desplazamiento lateral hidráulico.

Pompe hydraulique / Bomba hidráulica / Hydraulic pump

Desbrozadora ligera con ajuste horizontal hidráulico. Doble soporte de ruedas.

| Ajuste automático para obstáculos y troncos.

Tondeuse légère avec réglage hydraulique horizontal. Support de roue double.

| Bras auto-oscillant pour éviter tout obstacle.

Lightweight disc mower with horizontal hydraulic adjustment. Double wheel support. Self oscillating arm to avoid any obstacle.

|

Roçadeira de luz com ajuste horizontal hidráulica. Suporte de roda dupla.

| Intercepas de disco com regulação.

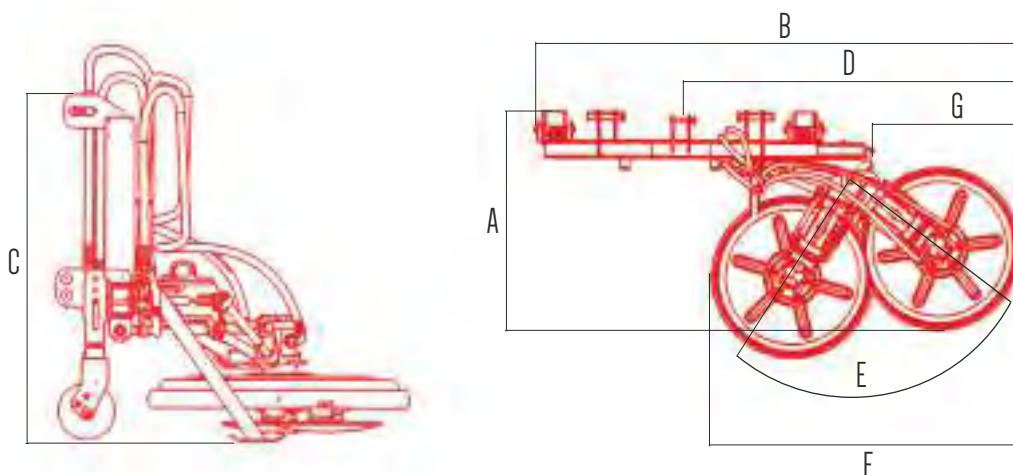

Disco lateral Ø 650 mm.

Cuchillas:

Espesor 8 mm.

Longitud 107 mm

Anchura 60 mm.

Referencia	Kg		A	B	C	D	E	F	G		€	
ESDESBHDISCOZ	140	620	2	950	2140-2570	935	1500-1925	83	1350	650	30-50	2.218 €

CABEZAL DESBROZADOR HIDRAULICO

Tête de broyage hydraulique / Cabeça trituradora hidráulica / Hydraulic mower head



MARTILLOS
MARTEAUX /
MARTÉLOS / HAMMERS



Cabezal desbrozador con bomba hidráulica.

Pompe hydraulique / Bomba hidráulica / Hydraulic pump

 Para miniexcavadora de 6 a 8 toneladas. Para ramas de hasta 5 cm. de diámetro. Doble chasis. Patines laterales. Motor hidráulico 100 L/min.

 Pour mini excavatrice de 6 à 8 tonnes. Pour les branches jusqu'à 5 cm. de diamètre. Double châssis. Patins latéraux. Moteur hydraulique 100 L / min. .00

 For mini excavator from 6 to 8 tons. For branches up to 5 cm. diameter. Double chassis. Lateral side skids. Hydraulic engine 100 L / min.

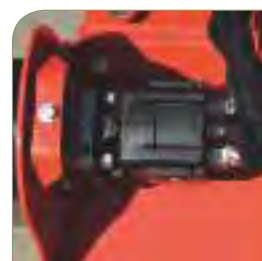
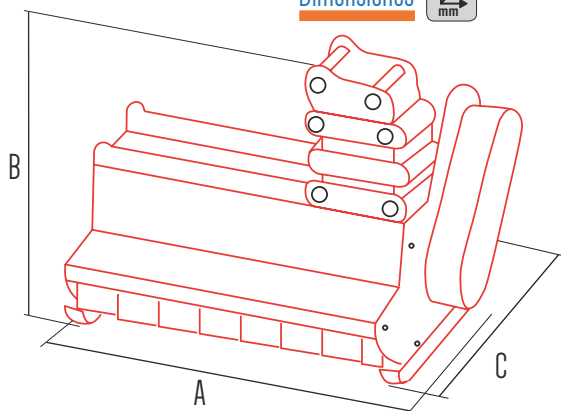

 Para Mini Escavadoras de 6 / 8 Toneladas. Diámetro de corte 5cm. Chassi duplo. Patins laterais. Motor hidráulico de 100 l / min.

Dimensiones 



Motor hidráulico caudal 100 l/min.

www.zeppelinmaquinaria.es

Referencia	A	B	C	 mm			Kg	€
ESCABHDRET80Z	940	850	920	790	12	3	268	2.337 €
ESCABHDRET100Z	1140	850	920	900	16	3	290	2.504 €
ESCABHDRET120Z	1340	850	920	1190	20	3	313	2.742 €

CAZOS

Cazos para Retroexcavadoras al tractor

Godets / Baldes para retroexcavadoras / Buckets

Referencia	mm	inch	mm	Kg	€
ESCAZO09Z	230	9	680	30	200 €
ESCAZO12Z	300	12	770	34	212 €
ESCAZO15Z	400	15	770	38	225 €
ESCAZO18Z	500	18	770	42	261 €
ESCAZO35Z	900	35	770	76	300 €

Para modelos pag. 34

ESRETH95Z, ESRETH95DZ (con acople especial)

ESRETH175Z, ESRETH195Z, ESRETH225Z



RETROEXCAVADORAS AL TRACTOR

Retroexcavadoras al tractor 3,2 mts.

Pelle rétro déportable/

Retroexcavadoras para o trator /

Backhoe



Dimensiones

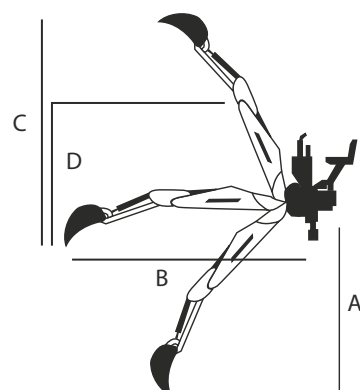

2000 mm



Máxima resistencia y durabilidad.
Construido con acero de alta calidad.
Visibilidad en el área de excavación.



Maximum strength and durability.
Made of high quality steel.
Perfect visibility in the excavation area.



Résistance et durabilité maximales.
En acier de haute qualité.
Visibilité parfaite dans la zone d'excavation.



Máxima resistência e durabilidade.
Construído com aço de alta qualidade.
Visibilidade na área de escavação.

Referencia	Cat.	Desplazable	A	B	C	D	mm	mm	Kg	hp	€	
ESRETH320Z	10	SI	3200 mm	2650 mm	3770 mm	3920 mm	2000	180°	508	1000	70-120	9.890 €

RETROEXCAVADORAS AL TRACTOR

Pelle Rétro/ Retroexcavadoras / Backhoe



Ver video Canal Zeppelin Maquinaria



ESRETH95Z

Referencia	Cat.	Desplazable	A	B	C	D	mm	mm	mm	Kg	hp	€
ESRETH95Z	1 y 2	NO	950 mm	2300 mm	2200 mm	1200 mm	1800	180°	300	400	18-25	4.410 €

Retroexcavadoras a tractor

Pelle rétro déportable /
Retroexcavadora com deslocamento /
Backhoe with shift

Ver video Canal Zeppelin Maquinaria



Desplazamiento lateral.

Dimensiones

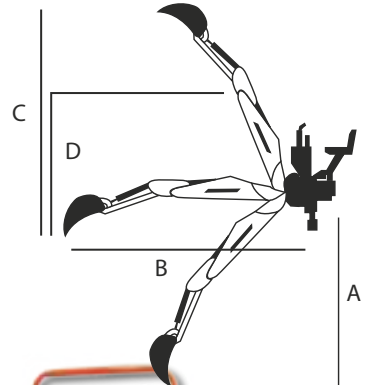

ESRETH225Z



Referencia	Cat.	Desplazable	A	B	C	D	mm	mm	mm	Kg	hp	€
ESRETH95DZ	1 y 2	SI	1000 mm	2300 mm	2200 mm	1200 mm	1800	180°	300	400	18-25	4.600 €
ESRETH175Z	1 y 2	SI	1750 mm	2600 mm	3120 mm	1800 mm	1700	180°	300	500	25-30	5.744 €
ESRETH195Z	1 y 2	SI	1950 mm	2900 mm	3170 mm	2000 mm	1700	180°	300	600	30-45	6.090 €
ESRETH225Z	1 y 2	SI	2250 mm	3300 mm	3450 mm	2300 mm	1700	180°	400	850	30-45	6.458 €

RETROEXCAVADORAS**Retroexcavadoras motor gasolina**

Pelle-rétro Thermique /

Retroexcavadoras com motor gasolina

Backhoe with engine

Gasolina
hp**EURO**
5**CANTAL****10**
HP**302 CC**

Ver vídeo Canal Zeppelin Maquinaria

Fuerza de Excavación 900 kg.
Capacidad de elevación: 200 Kg.
Depósito hidráulico: 15 litros
Depósito carburante: 6 litros.



Motor 4 Tiempos 10 hp.



Remolcable.



Mandos hidráulicos.

🇪🇸 Retroexcavadora autónoma con motor de 10HP, distribuidor hidráulico de 2 palancas, robusta y potente, remolcable por quad, tractor o vehículo, profundidad de excavación de 2100 mm y gran fuerza de trabajo. Incluye cazo 230 mm.

🇬🇧 Autonomous backhoe with 10HP engine, 2-lever hydraulic distributor, strength and powerful, towable by a quad, tractor or vehicle. 2100 mm excavation depth, great work force. Includes 230 mm bucket.

🇫🇷 Rétro-pelle autonome avec un moteur 10HP, distributeur hydraulique à 2 leviers, robuste et puissante, remorquable par quad, tracteur ou véhicule, profondeur d'excavation de 2100 mm et grande force de travail. Godet 230 mm inclus.

🇵🇹 Retroexcavadora autónoma com motor 10HP, distribuidor hidráulico com 2 alavancas, robusto e potente, rebocável por quadriciclo, tractor ou veículo, profundidade de escavação de 2100 mm e grande força de trabalho. Inclui balde de 230 mm.

Referencia	hp	mm	mm	mm	mm	mm	Kg	€	
ESRET10HPZ	10	2100	120°	2450	230	3250x1970x950	130°	466	3.756 €

Cazos para Retroexcavadoras motor

Buckets / Godets / Baldes para retroexcavadoras

Referencia	mm	Kg	€
ESRET09HP-C350	350	37	176 €
ESRET09HP-C600	600	48	243 €
ESRET09HP-C600V	600	45	254 €



350 mm.



600 mm.



600 mm. (V)

AHOYADORAS A TOMA DE FUERZA PARA TRACTOR

Tarière / Brocadoras-perforadoras / Post hole digger

Canal
Zeppelin
Maquinaria



ESA50Z. Modelo Mecánico.



ESAH50Z.
Modelo Hidráulico.

- Adaptable a diferentes tamaños de broca y tipos de suelo.
- | Diseñado para gran resistencia y durabilidad con brazo reforzado.
- Adaptable à tous les types de sol.
- | Structure renforcée. Haute résistance et durabilité.

- Adaptable to all types of soil.
- | Reinforced structure. High strength and durability.
- Adaptável a diferentes tamanhos de brocas e solo. Desenhado para ter grande resistência e durabilidade com braço reforçado.



Todo tipo de suelo.

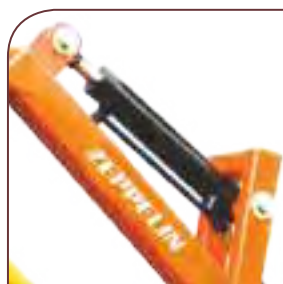

Modelo Hidráulico.



Puntas reforzadas.

Brocas	Inch	cms.	Kg.	€
ESBRO06Z	6"	15	14	221 €
ESBRO09Z	9"	23	20	242 €
ESBRO12Z	12"	30,5	26	257 €
ESBRO15Z	15"	38	36	284 €
ESBRO18Z	18"	45,7	47	320 €
ESBRO25Z	25"	63.5	65	368 €

Referencia		Kg				€
ESA50Z	1770x780x1880	132 kg	100x100	50	Mecánica/ Mechanical/ Mécanique	1.006 €*
ESAH50Z	1770x780x1880	155 kg	100x100	50	Hidráulica/ Hydraulic/ Hydraulique	1.465 €*



Longitud 130 cm.

*Broca de 12" incluida en el precio. *Mèche de 12" inclus. *12" auger included.

AHOYADORA HIDRAULICA ADAPTABLE A PALA DE TRACTOR

Tarière hydraulique pour les tracteurs et les valets de ferme / Brocadora - perforadora hidráulica para tractores e carregadores. / Hydraulic post digger for tractor and wheel loader

- Enganche EURO B:
Ancho 1060 mm. Alto 300 mm.
Velocidad de barrena: 65 RPM
Diámetro de barrena: 300 mm.
Largo de barrena: 1300 mm.
Presión de trabajo: 16 Mpa
Flujo Hidráulico: 75 L/min.

- EURO B link:
Width 1060 mm. High 300 mm.
Auger speed: 65 RPM
Auger diameter: 300 mm.
Auger length: 1300 mm.
Working pressure: 16 Mpa
Hydraulic flow: 75 L/min.

- Attelage EURO B:
Largeur 1060 mm.
Hauteur 300 mm.
Vitesse mèche: 65 RPM
Diamètre mèche: 300 mm.
Longueur mèche: 1300 mm.
Pression de travail: 16 Mpa
Débit hydraulique: 75 L/min.

- Engate Tipo EURO B (Carregador Frontal):
Largura 1060 mm. Altura 300 mm.
Velocidad de barrena: 65 RPM
Diámetro do broca: 300 mm.
Comprimento broca: 1300 mm.
Pressão de trabalho: 16 Mpa
Fluxo Hidráulico: 75 L/min.

Referencia			Kg	€
ES71543	1300	2070x1060x440	115	1.680 €



GRÚA HIDRÁULICA

Grues / Guindaste / Cranes



* ESGR180Z



* ESGR180HZ

Giro Hidráulico 36°.





Grúa hidráulica tripuntal.

Grues / Guindaste / Cranes

 Altura total: 2.340 mm
 Longitud extendida del brazo: 2.050 mm
 Recorrido del cilindro: 800 mm.
 Peso máx. elevable: 1.200 kg.
 Altura max. elevación: 1.800 mm.

 Hauteur totale: 2.340 mm
 Longueur de bras étendue: 2.050 mm
 Course du cylindre: 800 mm.
 Poids max.: 1.200 kg.
 Capacité de levage: 1.800 mm.

 Altura total: 2.340 mm
 Comprimento do braço estendido: 2.050 mm
 Curso do cilindro: 800 mm.
 Peso máximo Elevador: 1.200 kg.
 Altura máxima Elevação: 1.800 mm.

 Total height: 2.340 mm
 Extended arm length: 2.050 mm
 Cylinder stroke: 800 mm.
 Max. Lifting Weight: 1.200 kg.
 Max. Lifting Height: 1.800 mm.

Referencia	Kg			€
ESGR180Z	250 kg	30-45	Mecánica	1.890 €
ESGR180HZ	290 kg	30-45	Hidráulica Radio Giro máx. 36°	2.455 €

SEGADORAS A TOMA DE FUERZA PARA TRACTOR

Segadoras de tambor

Rotary drum mowers / Faucheuses à tambours / Ceifeiras de tambos



ES Segadora de tambor gama estándar.
Modelos hidráulicos y mecánicos.
Incluye protección.

UK Standard range drum mower.
Hydraulic and mechanic models.
Plastic protection included.

FR Faucheuse à tambours de gamme standard.
Modèles hydrauliques et mécaniques.
Protection plastique inclus.

PT Ceifeiras de tambor Gama Standar.
Modelos hidráulicos e mecânicos.
Proteção incluída.



Modelo Hidráulico.



Protección.

Gama estandar

Referencia	mm	hp	⊙	📏	rpm	Ø mm	PTO r/min	Kg	✎	€
ESSEG135M	1350	27	2	4	2070	680	540	300	Mecanic	2.315 €
ESSEG135H									Hydraulic	2.657 €
ESSEG165M	1650	54	2	6	2070	780	540	360	Mecanic	2.389 €
ESSEG165H									Hydraulic	2.741 €
ESSEG185M	1850	75	2	6	2000	880	540	405	Mecanic	3.019 €
ESSEG185H									Hydraulic	3.407 €



Gama ligera

Referencia	mm	hp	⊙	📏	PTO r/min	Kg	€
ESSEG100L	1000	10-35	2	6	540	140	1.271 €
ESSEG135L	1350	22-40	2	6	540	180	1.418 €



Nivel de aceite / Huile / Oil / Óleo

ES Segadora de tambor gama ligera.
Con soporte giratorio.
Incluye protección.
Cardan doble, NO INCLUIDO.

FR Faucheuse à tambours légère pour microtracteur. Bras pivotant.
Cardan double, NON INCLUS.
Protection plastique incluse.

UK Lightweigh drum mower.
Swivel arm.
Double cardan, NOT INCLUDED.
Plastic protection included.

PT Ceifeira de tambor gama ligeira.
Com suporte rotativo.
Inclui proteção.
Cardan duplo, NÃO INCLUIDO.

PODADORA EN ALTURA PARA TRACTOR

Taille-Haie / Podadora em altura / Flail hedge trimmer

ZCUTTER

**DOBLE BOMBA
MUELLE DE RETORNO EN BARRA DE
CORTE
VÁLVULA DOBLE
BRAZO PRINCIPAL REFORZADO**



Esta podadora de brazo en altura, es muy adecuada para tractores compactos y medianos. El brazo de siega se complementa con el cortador de setos con un ancho de trabajo de 160 cm.

Ce taille-haie est idéal pour le monter sur les microtracteurs. Le bras extensible est complété par un lamier sécateur d'une largeur de travail de 160 cm.

Esta podadora de braço em altura é muito adequada para tratores compactos e médios. O braço de corte é complementado pelo corta-sebes com uma largura de trabalho de 160 cm.

This flail hedge trimmer is very suitable for compact and small tractors. The arm is complemented with a 160 cm length trimmer.

Dimensiones

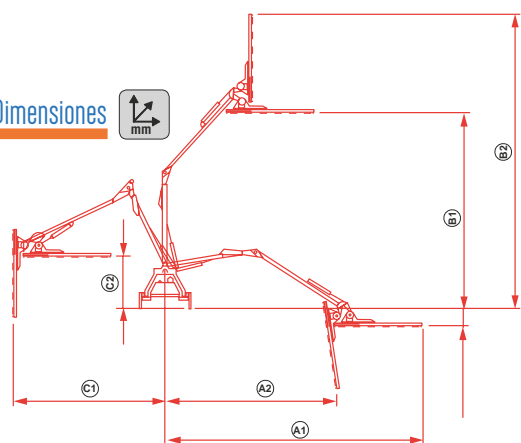

Peine de cuchillas y dedos.
ES71527



Grupo multiplicador.
Caudal 50 litros/minuto.

Referencia	mm	Kg	Depósito Aceite	hp	PTO r/min	A1	A2	B1	B2	C1	C2	€
ESPODH1600HZ	1.600	300	20L	25-40	540	160°	320°	370°	5500 mm	2800 mm	1000 mm	3.960 €

BARREDORA

Barredora al tractor y carretilla elevadora

Balayeuse / Varredora para o tractor e empilhador / Sweeper



- Altura y ángulo de limpieza ajustable. Incluye depósito de residuos. Ideal para terreno horizontal y sólido. Adaptable a tractor y carretilla elevadora.
- Hauteur et angle de nettoyage réglables. Dépôt des déchets inclus. Idéal pour le sol horizontal et solide. Adaptable tracteur et fenwick.
- Limpeza ajustável em altura e ângulo. Inclui depósito de resíduos. Ideal para terrenos horizontais e sólidos. Adaptável ao tractor e empilhador.
- Adjustable height and cleaning angle. Waste collection box included. Ideal for the plain and solid soil. Adaptable for tractor and forklift.

Referencia	mm	l/min	r/min	Kg	hp	€
ESBARREDOR150Z	1500	18-30	100-180	298	18-50	2.147 €

Barredora restos de poda frutal y viña al tractor

Balayeuse de sarments / Varredora de poda de fruta e vinha. / Sweeper for branches

MOD. CEPILLOS CON VARILLAS

ES70727



MOD. MONO BRAZO CON VARILLAS DE METAL

ES71666

Dos bombas.



MOD. CEPILLOS CON FALDONES

ES70705

Regulación independiente en cada brazo.



Referencia	Tipo	n°	min mm	max mm	hp	€
ES71666	(Varillas acero)	1	700	700	50-100	2.800 €
ES70727	(Varillas nylon)	2	1500	4200	50-100	4.625 €
ES70705	(Faldón)	2	1500	4200	50-100	4.085 €

RASTRILLOS DE SOLES

Wheel hay rakes / Andaineurs soleil / Volta fenos de tipo Girassol

4 ó 5 SOLES

Buje 6 tornillos



Referencia	n°	mm	mm	hp	Kg	n°	€
ESRAST04MZ-6B	4	4000x2100	220-260	30-50	160	160	947 €
ESRAST05MZ-6B	5	5300x2300	330-350	30-90	190	200	1.082 €

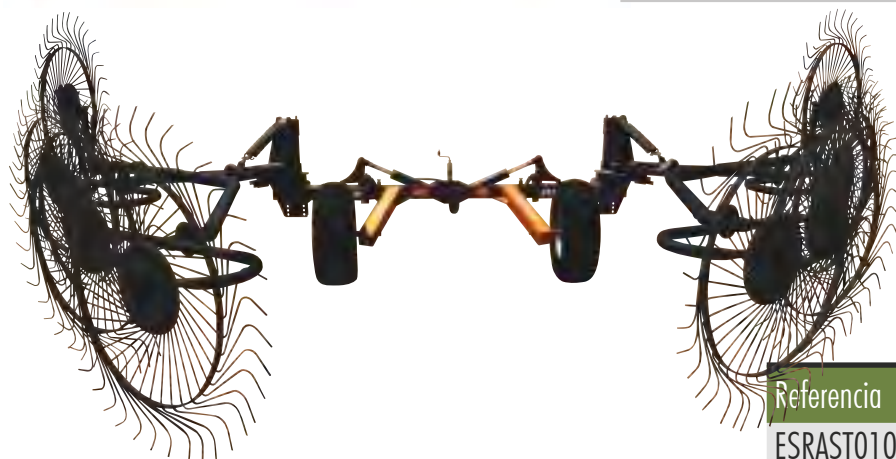

10 SOLES

Hidráulico

Referencia	n°	mm	mm	mm	hp	€
ESRAST010HZ	10	7600	3000	520-700	45-90	5.840 €

RASTRILLOS DE BRAZOS

Andaineurs à bras / Volta fenos de braços / Arm rakes

- **Rastrillo henificador.** Airear, extiende, hilera, y apila para un secado más rápido.
- **Adaineur faneur.** Regroupe le foin après fanage et mettre en andain le foin ou la paille lors de l'andainage. Accélère le séchage du foin.
- **Volta fenos de braços.** Com ajuntador. Estende, prepara linhas para que as culturas sequem mais rápido.
- **Hay rake.** Regroups the hay after tedding and puts in hay windrow or straw during windrowing. Accelerates the hay drying

Referencia	mm	Kg	mm	€
ESRAST012Z	2100x250x950	165	1800	6

MODELO 6 BRAZOS

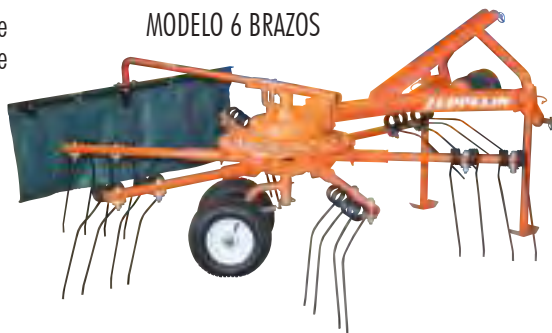

n°	PTO r/min	hp	€
12	540	18-50	1.287 €



MODELO 9 BRAZOS



GRUPO: C.M.R. (9-11) brazos

www.zepelinmaquinaria.es

Referencia	mm ³ TRANSPORTE	Kg	mm	€
ESRAST035Z	3200x2900x1550	450	3500	9
ESRAST042Z	3200x2900x1550	540	4200	11

EMPACADORAS COMPACTAS DE PACAS REDONDAS

Presse à balles rondes / Enfardadeira redonda compacta / Round baler

EMPACADORA 50Z - 70Z



ES Peso de las balas (paja seca):
| 18–25 KG (50Z) , 20-35 KG (70Z).

GB Bale weight (dry hay):
| 18–25 KG (50Z) , 20-35 KG (70Z).

FR Poids des balles (foin sec) : 18–25 KG (50Z) ,
| 20-35 KG (70Z).

PT Peso dos fardos (palha seca): 18–25
| KG (50Z) , 20-35 KG (70Z).



Referencia	mm	Kg	mm	mm	Km/h	PTO r/min	hp	€
ESEMPAC050Z	1200x1350x1280	404	500x700	800	2-5	540	18-48	5.040 €
ESEMPAC070Z	1300x1360x1380	452	600x700	800	2-5	540	20-60	5.565 €

Encintadora de pacas

Enrubanneuse thermique pour balles rondes / Embaladora de fardos redondos / Bale wrapper



ES Máquina para encintar balas
de césped, de arroz y paja.

FR Enrubanneuse pour les
balles rondes.

PT Máquina embalar
erva, arroz e palha.

GB Wrapper for round
bales.

Referencia	mm	Kg	mm	hp	€
ES70474	1500x870x1030	85	600x700	6	2.604 €



MOTOR: Subaru 6 HP



EMPACADORAS**EMPACADORA 90Z PACA REDONDA**

Presse à balles rondes / Enfardadeira redonda compacta / Round baler

🇪🇸 Máquina para empaçar balas de hierba y paja.
Peso de las balas (paja seca): 50 – 80 KG





🇫🇷 Machine pour la préparation des balles de fenaison.
Poids des balles (foin sec) : 50 – 80 KG

🇵🇹 Máquina para embalar rolos de erva e palha.
Peso dos fardos (palha seca): 50 – 80 KG

🇬🇧 Machine to make hay bales.
Bale weight (dry hay): 50 – 80 KG



RUEDAS: 16 x 6.6-8-4PR

Referencia	 mm	Kg	 mm	 mm	Km/h	PTO r/min	 hp	€
ESEMPAC090Z	2450 x 1850 x 1600	930	850x900	900	5-8	540	+40	10.660 €

EMPACADORA 190Z PACA RECTANGULAR

Presse à balles carrées / Enfardadeira praça compacta / Square baler

🇪🇸 Sistema de recogida de agujas
Sistema anudador alemán.
Formación de paca mediante prensado.
Longitud (300-1200 mm.) y densidad ajustable.

🇫🇷 Système de collecte d'aiguilles
Système de liage de précision allemand.
Formation de la balle par système de pressage.
Longueur (300-1200 mm.) Et densité réglable.

🇵🇹 Sistema de recolha por agulhas.
Sistema de amarração alemão.
Formação do fardo compactado.
Comprimento (300-1200 mm.)
E densidade ajustável.

🇬🇧 Needle collection system
German knotter system.
Bale formation by pressing.
Length (300-1200 mm.) And adjustable.



Referencia	 mm	Kg	 mm	 mm	Km/h	PTO r/min	 hp	€
ESEMPAC190Z	4650 x 2500 x 1800	1690	360x460	1900	4-7	540	40-80	21.430 €

ENSILADORA DE MAIZ

Ensileuse de maïs / Ensiladora de milho I linha / Maize chopper



- -
- Corta y tritura el maíz para obtener forraje y carga directamente al medio de transporte.
- Cuts and grinds corn to obtain forage and load it in a transport (bale trailer).
-
- Coupe et broie du maïs pour obtenir le fourrage et charge directement à la remorque.
-
- Corta e esmaga o milho para obter forragem e carregar diretamente para um meio de transporte.

Referencia	mm	mm	Kg		PTO r/min	€
ES70589	2400X3200X2350	500	550	12	540	5.950 €

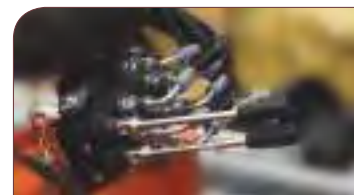

Detalle del distribuidor hidráulico.



Ruedas de transporte.

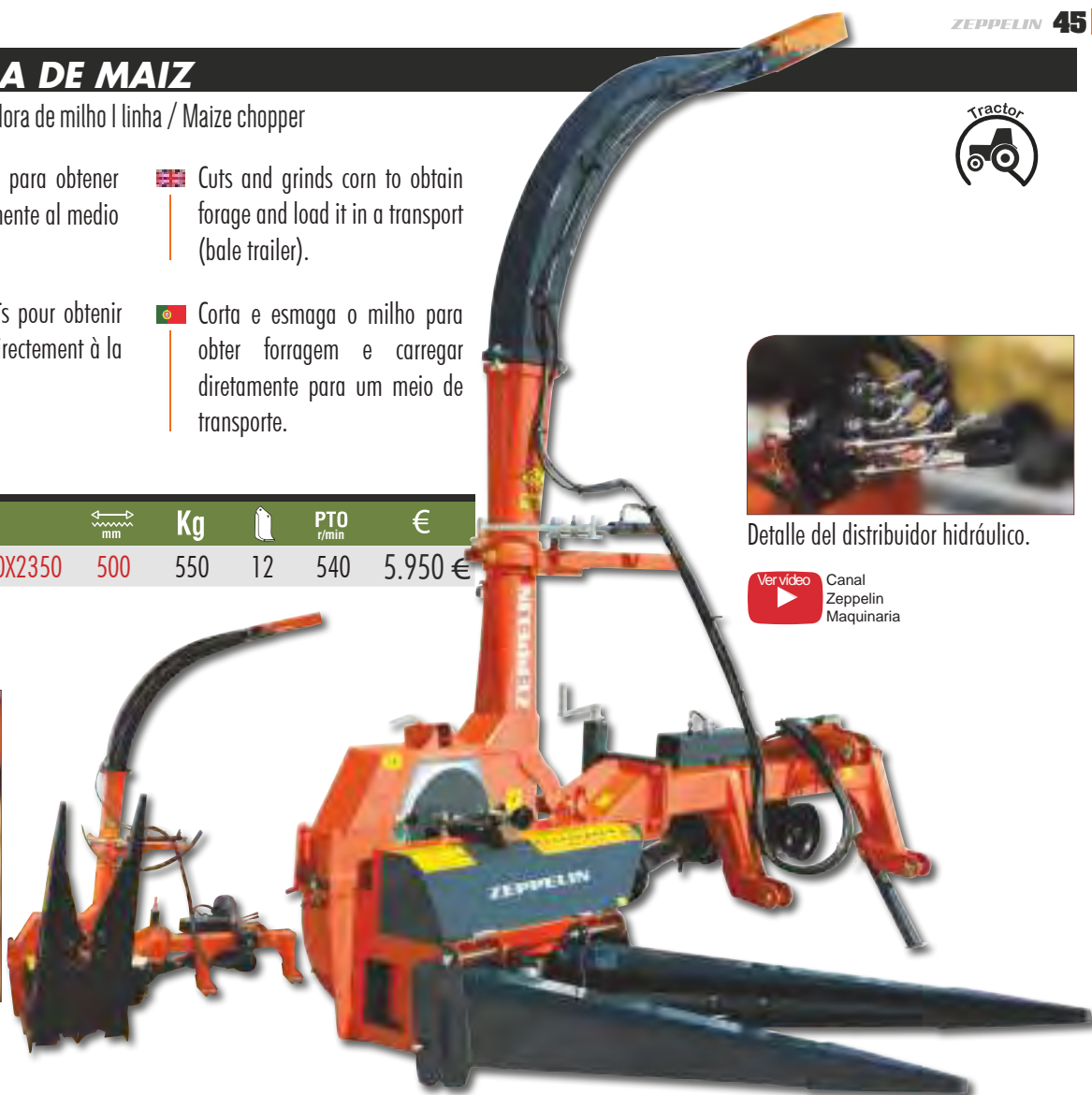

COSECHADORA DE FORRAJE

Ensileuse pour fourrages / Corta Forragens de erva / Forage harvester Chopper



- -
-
- Obtener forraje o alimentar animales directamente.
- To obtain forage or direct animal feeding.
- Ancho de transporte: 1.450 mm
- Transport position length: 1.450 mm
-
- Pour obtenir du fourrage ou l'alimentation des animaux directement.
-
- Obter forragem ou alimentar os animais diretamente.
- Largura de transport: 1.450 mm
- Largura de transporte: 1.450 mm

Referencia	mm	mm		Kg		PTO r/min	€
ES70935	1450X3570X3080	1300	4	550	21	540	5.650 €

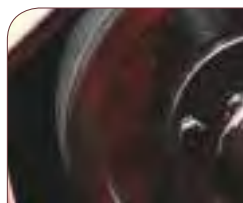

Transmisión por correas.

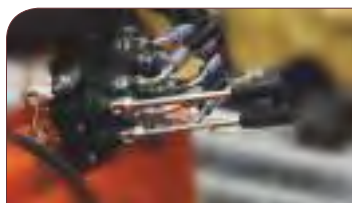

Detalle del distribuidor hidráulico.



GRADAS

- Actúa como procesadora de residuos antes del cultivo.
Rotura de superficies endurecidas impermeables y del terreno después del cultivo. Alisamiento del terreno y preservación de la humedad del suelo. Gran capacidad de penetración.
- Fonctionne comme un processeur de déchets avant la culture.
Brise les surfaces dures imperméables. Brise le sol après la culture.
Lissage du sol et préservation de l'humidité du sol. Capacité de pénétration élevée.

- Works as a waste processor before cultivation.
Breaks impermeable hard surfaces. Breaks the soil after cultivation.
Smoothing the soil and preserving soil moisture. High penetration capacity.
- Atua como um processador de resíduos antes do cultivo.
Permite a permeabilização dos solos. Remove a terra após o cultivo.
Nivelamento do solo e preservação da humidade. Grande capacidade de penetração.

Gradas de discos suspendidas en X. 110-170 cm.

Herse X à disques portés / Grades de discos X suspendidas / Disc harrows in X liftmounted

ESGRADA20Z



Gradas suspendidas en X. Discos de Ø450 mm.



Discos dentados.

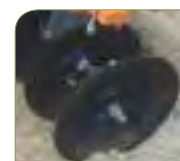

Discos lisos.

Referencia	Kg	↔ mm	↑ mm	○	○ Ø mm	○ Ø cc	↖ Cat.	↖ hp	€
ESGRADA12Z	260	1100	160	12	450	18	1°	15-30	1.570 €
ESGRADA16Z	330	1400	160	16	450	18	1°	25-35	1.720 €
ESGRADA20Z	410	1700	160	20	450	18	2°	40-55	1.828 €

Gradas de discos suspendidas en V. 140-220 cm.

Herse V à disques portés / Grades de discos V suspendidas / Disc harrows in V liftmounted



Discos dentados.



Discos lisos.



ESGRADA16ZR

Gradas suspendidas en V.
Discos de Ø560 mm.
Modelos ZR

Referencia	Kg	↔ mm	↑ mm	○	○ Ø mm	○ Ø cc	↖ Cat.	↖ hp	€
ESGRADA12Z20	324	1400	160	12	510	20	1-2°	40	1.694 €
ESGRADA16Z20	390	1800	160	16	510	20	1-2°	45	1.828 €
ESGRADA20Z20	463	2200	160	20	510	20	1-2°	55-65	1.945 €
ESGRADA16ZR	430	1900	160	16	560	22	1-2°	55-65	1.845 €
ESGRADA20ZR	480	2200	160	20	560	22	1-2°	55-65	2.050 €

GRADAS RÁPIDAS

Gradas de discos 140-300 CM

Déchaumeur à disques / Grades de discos / Disc harrow

ACCESORIO RULO PACKER



ESGRADARAP180Z



Ver vídeo Canal Zeppelin Maquinaria

- DE 10 a 24 DISCOS AMA 560 mm. de diámetro. (ESPESOR 4 mm.)
 ÁNGULO DE DISCO INCREMENTADO, MAYOR ÁNGULO DE ATAQUE.
 RODAMIENTOS REFORZADOS INTEGRADOS SIN MANTENIMIENTO.
 - Doble hilera de discos con un diámetro de 560 mm. (22 pulgadas)
 - Eje tubular trasero y pantallas laterales.
 - Brazo de tracción ABS automático (sin pasadores).

- DISQUES AMA 560 mm. de diámetro. (ÉPAISSEUR 4 mm.)
 ANGLE DE DISQUE AMÉLIORÉ. PLUS GRAND ANGLE D'ATTAQUE.
 ROUEMENTS RENFORCÉS INTÉGRÉS SANS ENTRETIEN.
 - Double rangée de disques d'un diamètre de 560 mm. (22 pouces)
 - Arbre tubulaire arrière et écrans latéraux.
 - Bras de traction ABS automatique (sans broches).

- DISCO AMA 560 mm. de diámetro. (ESPESURA 4 mm.)
 ÁNGULO DE DISCO INCREMENTADO, MAIOR ÁNGULO DE ATAQUE.
 ROLAMENTOS REFORÇADOS INTEGRADOS, SEM MANUTENÇÃO.
 - Fileira dupla de discos com um diâmetro de 560 mm. (22 polegadas)
 - Eixo tubular traseiro e telas laterais.
 - Braço de tração ABS automático (sem pinos).

- DISKS AMA 560 mm. diameter. (THICKNESS 4 mm.)
 INCREMENTED DISC ANGLE, GREATER ANGLE OF ATTACK.
 INTEGRATED REINFORCED BEARINGS, WITHOUT MAINTENANCE.
 - Double row of discs with a diameter of 560 mm. (22 inch)
 - Rear tubular shaft and Side screens.
 - Automatic ABS traction arm (without pins).



Soporte independiente para cada disco.



Ángulo de entrada ajustable

Referencia	Kg	mm	mm	nº	Ø mm	Ø''	mm	hp	€	OPCIÓN RULO PACKER	€
ESGRADARAP140Z	570	1400	160	10	560	22	1550x2150x1330	45	4.085 €	-	
ESGRADARAP160Z	670	1600	160	12	560	22	1750x2150x1330	50	4.170 €	-	
ESGRADARAP180Z	770	1800	160	14	560	22	1950x2150x1330	55	4.350 €	-	
ESGRADARAP200Z	870	2000	160	16	560	22	2150x2150x1330	60	4.620 €	-	
ESGRADARAP220Z	930	2200	160	18	560	22	2350x2150x1330	65	5.050 €	-	
ESGRADARAP250Z	1100	2500	160	20	560	22	2650x2150x1330	80	6.230 €	ESGRADARAP250ZP	7.661 €
ESGRADARAP270Z	1200	2700	160	22	560	22	2850x2150x1330	90	7.040 €	ESGRADARAP270ZP	8.657 €
ESGRADARAP300Z	1300	3000	160	24	560	22	3150x2150x1330	100	7.155 €	ESGRADARAP300ZP	8.799 €
ESGRADARAP300SR							SIN RULO		6.744 €		
ESGRADARAP300R							RULO 3000 mm.				

SUBSOLADORES

Subsoladores ligeros

Sous-soleuses légères / Subsoladores Ligeiros / Light subsoilers



ESRI3Z

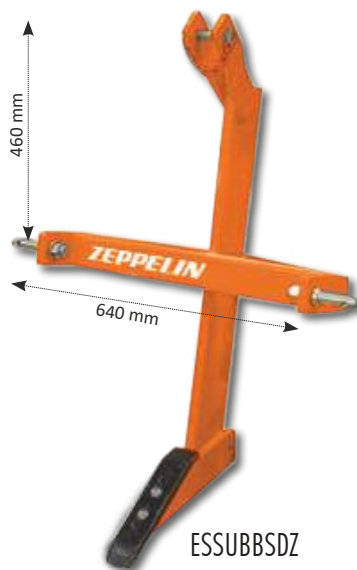

ESSUBSDZ

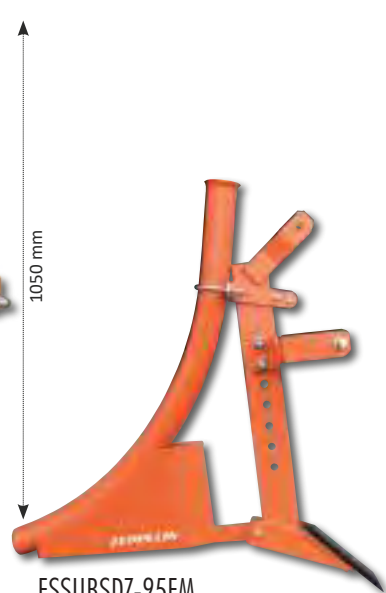

ESSUBSDZ-95EM

Subsolador + Enterrador de manguera.
Diámetro máx. manguera: 75 mm

Referencia	mm	Kg	mm	n° Dientes Dientes	mm	hp	€
ESSUBSDZ	640x430x1100	45	65	1	200*	15-30	525 €
ESSUBSDZ-95EM	640x430x1100	95	65	1	200*	15-30	660 €
ESRI3Z	1200x550x1250	170	1200	3	320-500	25-35	896 €

*Posibilidad de regular la profundidad de trabajo.

ARADOS Y GRADAS

Arados de vertedera reversibles

Charrues réversibles / Charruas reversíveis / Reversible Ploughs

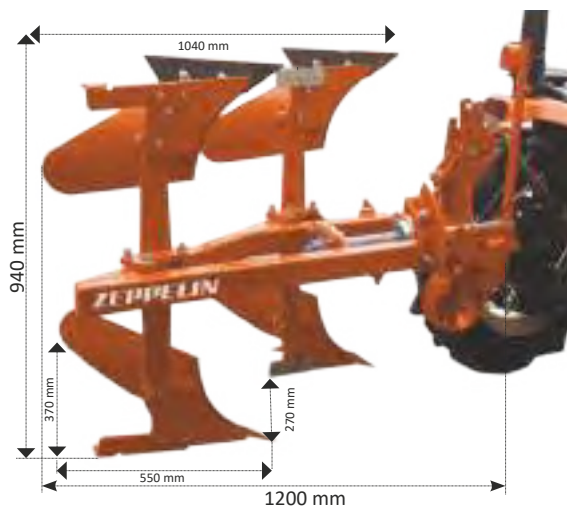
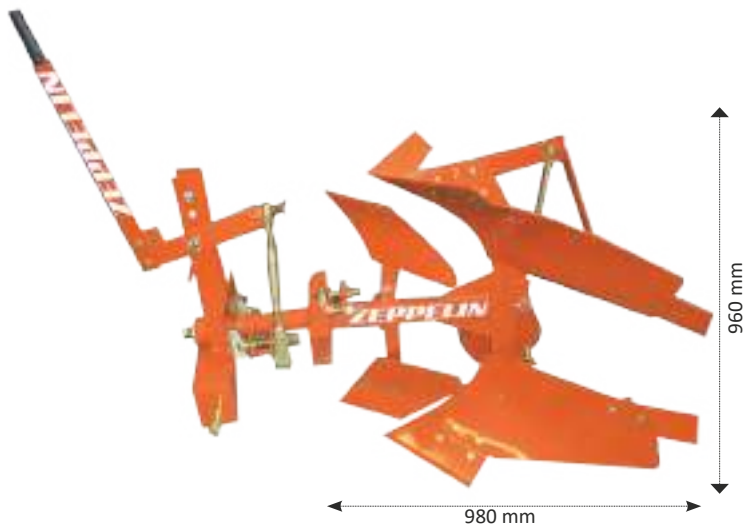

Rejas



Rueda de profundidad.

Referencia	mm	Kg	mm	mm	€
ESAR03Z	960x650x980	110	360	200	672 €
				Monosurco One Furrow Monosoc	

Referencia	mm	Kg	mm	mm	€
ESAR04Z	940x1040	135	450	200	793 €
				Bisurco Two Furrow Double soc	

SUBSOLADORES

Subsoladores reforzados

Sous-soleuses renforcées / Subsoladores Reforçados / Reinforced subsoilers

Canal Zeppelin Maquinaria

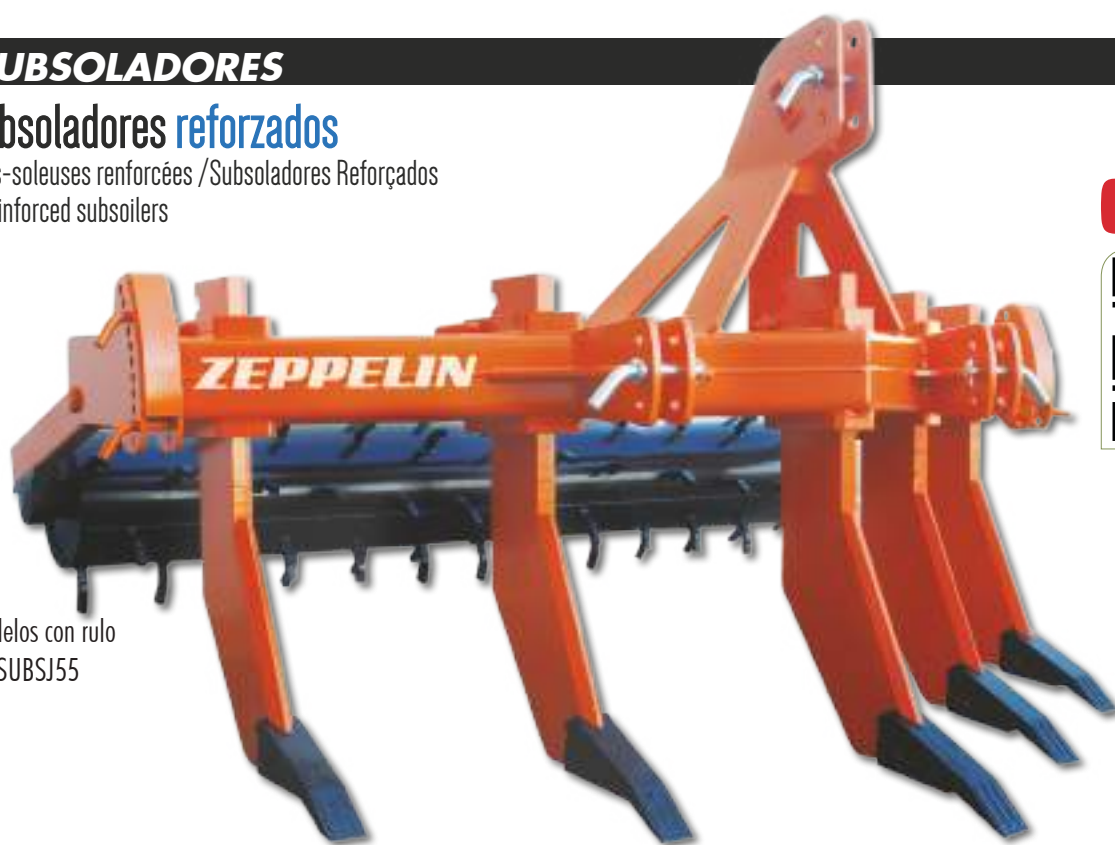

*Modelos con rulo
ESSUBSJ55



*Modelos 3 hileras con rulo



Rulo opcional ESSUBSJ55-R.



Bota de acero.



Regulable en altura.

Gran robustez.

Ideal para remover capas duras para conservar la humedad.

Très robuste et solide.

Idéal pour enlever les couches dures de terrain et conserver l'humidité du sol.

Very robust and solid.

Ideal for removing hard layers of soil and keeping the soil with humidity.

Grande robustez

Ideal para remover camadas duras para conservar a humidade.

Referencia	Anchura total	nº de hileras	mm	mm	mm	D ^{esp}	hp	Cat.	kg	kg	€	
ESSUBSJ25	774	2	30x155	665	450	740 mm	30/60	II	-	207	-	1.390 €
ESSUBSJ35	1400	3	30x155	1220	450	740 mm	50/60	II	-	280	-	1.795 €
*ESSUBSJ35-R	1400	3	30x155	1220	450	740 mm	50/60	II	470	280	480	2.429 €
ESSUBSJ55	2400	5	40x180	2200	550	800 mm	90/130	II	-	640	-	2.950 €
*ESSUBSJ55-R	2400	5	40x180	2200	550	800 mm	90/130	II	515	640	840	3.646 €

PREPARACIÓN DEL TERRENO

Rastra niveladora

Herse niveleuse /
Grade escavadora niveladora /
Harrow grader

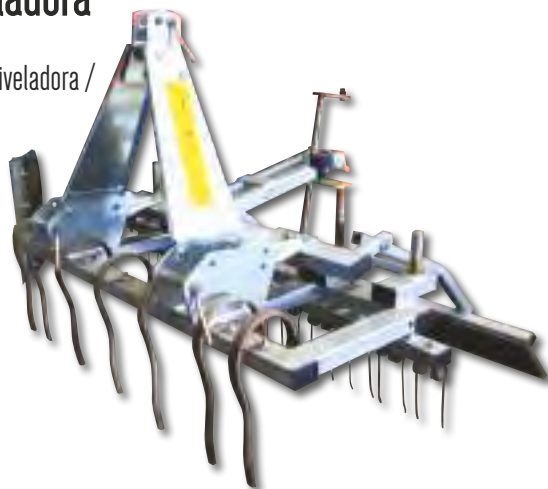

TRACTOR
ES70781
ES70894



ES 7 púas delanteras. (120 cm)
11 dobles intermedias. (120 cm)
11 púas delanteras. (200 cm)
17 dobles intermedias. (200 cm)

FR 7 dents simples avant (120 cm)
11 doubles dents (120 cm)
11 simples dents avant (200 cm)
17 doubles dents (200 cm)

PT 7 dentes dianteiros. (120 cm)
11 molas duplas intermediárias (120 cm)
11 dentes dianteiros. (200 cm)
17 molas duplas intermediárias (200 cm)

UK 7 front tines. (120 cm)
11 middle double tines (120 cm)
11 front tines. (200 cm)
17 middle double tines. (200 cm)

Referencia	Kg	mm	hp	€
ES70781	105	1200	18-25	925 €
ES70894	125	2000	18-60	1.080 €



Hoja trasera de nylon.



Fresa Acaballadora

Bed former / Fraise Butteuse / Fresa - Armador de Camalhões



ES Diseñada para cualquier tipo de hierba o cubierta de tierra.
Refuerzos superiores de la estructura en modelo reforzado.
Equipada con biela frontal y sistema de suspensión con cadenas.

FR Prête pour tout type d'herbe ou de couverture de terre.
Renforts supérieurs de la structure. Équipée d'une bielle avant et d'un système de suspensions avec des chaînes.

PT Desenhada para qualquer tipo de erva ou cobertura do solo.
Reforços superiores na estrutura de modelos reforçados.
Equipada com biela dianteira e sistema de suspensão com correntes.

UK Designed for any type of grass or ground cover.
Upper reinforcements of the structure.
Equipped with a front rod and a suspension system with chains.



Referencia	Kg	mm	mm	PTO r/min	hp	Ancho cama	Altura cama	€	
ESACAB160RZ	430	1500	120	36	540	45-60	1100 mm	250 mm	4.200 €
ESACAB180RZ	550	1750	120	40	540	65-80	1200 mm	250 mm	5.455 €

PREPARACIÓN DEL TERRENO

Grada Rotativa

Power harrow / Herse rotative / Grade rotativa

ES Preparación del lecho de siembra.
Rulo de tubos para cultivos especiales.
Barra niveladora para adaptación en altura.

FR Préparation du lit de semence.
Rouleau à tubes ou à grille pour les cultures spéciales.
Rampe niveleuse pour le réglage en hauteur.

PT Preparação do terreno das sementeiras
Rolo de tubo para culturas especiais.
Barra de nivelamento com regulação de altura.

UK Preparation of the seedbed.
Tube or cage roller for special cultivation.
Levelling bar for height adjustment.



Tipo de rulo con tubos. Mod. Z

Tipo de rulo con rejilla. Mods. ZR

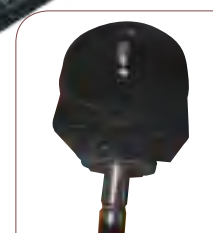

Grupo

Referencia	Kg					PTO r/min		€
ESGRADAROT135Z	280	12	1300	200	tubos	540	25-35	1.775 €
ESGRADAROT135ZR	280	12	1300	200	rejilla	540	25-35	1.775 €
ESGRADAROT175Z	330	16	1700	200	tubos	540	40-70	1.995 €
ESGRADAROT175ZR	330	16	1700	200	rejilla	540	40-70	1.995 €
ESGRADAROT200Z	400	20	2000	200	tubos	540	70-120	2.849 €
ESGRADAROT200ZR	400	20	2000	200	rejilla	540	70-120	2.849 €



Nivelador de rulo



Detalle cuchillas.

Fresa enterradora de piedras

Enfouisseur de pierres / Fresa Enterradora de pedras / Stone Burier

TRANSMISIÓN POR CADENAS

ES Entierra piedras pequeñas.
Nivela y comprime el terreno.
Compacta el lecho de siembra.
Sentido del giro de las cuchillas, de delante hacia atrás.

FR Enfouisse des petites pierres.
Nivèle et comprime le sol.
Compacte le lit de semence.
Sens de rotation des couteaux, de l'avant à l'arrière.

UK Buries the small stones.
Level and compress the soil.
Compact the seedbed.
Rotation of the blades, front to back.

PT Enterra pequenas pedras. Nivela e comprime o terreno.
Preparação do terreno das sementeiras. Sentido de rotação das lâminas, da frente para trás.



Máquina trabajando.



Grupo reforzado.

Referencia			PTO r/min				Kg	€
ESPD950	1210x1070x920	950	540	20-28	5	20	330	1.945 €
ESPD1150	1210x1270x920	1150	540	25-30	6	24	355	2.028 €
ESPD1350	1210x1470x920	1350	540	28-40	7	28	380	2.115 €
ESPD1550	1210x1670x920	1550	540	35-60	8	32	405	2.331 €

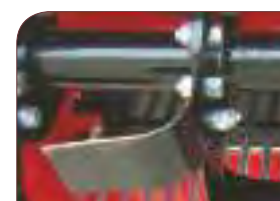

Detalle de la cuchilla.

PALAS DELANTERAS PARA TRACTOR

Chargeurs frontaux / Carregadores Frontais / Front end Loader

Las palas se entregan con elementos de sujeción, siendo necesaria su adaptación. Distribuidor Hidráulico incluido.

Les chargeurs sont livrés avec des attelages de fixation, devant être adapté pour le montage au tracteur. Distributeur hydraulique inclus.

Os Carregadores Frontais são entregues com elementos de fixação, sendo necessária a sua adaptação. Distribuidor Hidráulico incluído.

Front end loaders are delivered with fasteners, which must be adapted for mounting to the tractor. Hydraulic distributor included.



Para modelos
TIPO KUBOTA
ESPAKU01Z - B7001
ESPAKU02Z - B1200 1400-1502
ESPAKU03Z - L1802DT-L2002DT





Para modelos
TIPO KUBOTA
ES70628











Para modelos TIPO STANDARD
ES70570 - 254 Modelo 25 hp
ES70571 - 504 Modelo 50 hp



Tipo KUBOTA

Referencia	 mm	 m ³	 Kg	 mm	 mm	 mm			Kg	€
ESPAKU01Z	1100 (1150-1250)	0,12	100	1.810	1300	100	15°	41°	315	2.825 €
ESPAKU02Z	1100 (1150-1250)	0,12	100	1.810	1300	100	15°	41°	315	2.825 €
ESPAKU03Z	1400 (1150-1250)	0,12	150	1.920	1440	100	15°	41°	370	2.825 €

Tipo KUBOTA 954

Referencia	 mm	 m ³	 Kg	 mm	 mm	 mm			Kg	€
ES70628	2.260	0.60	1.000	3.065	2.830	189	30,9°	88.5°	950	5.775 €

Tipo STANDARD

Referencia	 mm	 m ³	 Kg	 mm	 mm	 mm			Kg	€
ES70570	1.370	0.20	380	2.200	1.210	100	35°	60°	410	2.951 €
ES70571	1.670	0.28	600	2.700	1.930	150	35°	70°	695	3.654 €

PALA TRASERA PARA TRACTOR

Back end Loader / Chargeur arrière / Pá Carregadora Traseira

Canal Zeppelin Maquinaria



- 5 Pinchos desmontables.
Enganche al tractor 3 puntos. Lateral desmontable. Distribuidor hidráulico doble. Brazo telescópico 3 puntos.
- 5 pics à balles amovibles.
Attelage tracteur 3 points. Côtés amovibles. Bras télescopique 3 positions. Distributeur hydraulique double.

- 5 removable bale spears.
3 point tractor hitch. Removable sides. 3 positions telescopic arm. Double hydraulic distributor.
- 5 Dentes desmontáveis.
Encaixe aos 3 pontos do trator. Painéis laterais destacáveis. Distribuidor hidráulico duplo. Braço telescópico.

Referencia	 mm	Altura. máx. mm	 Kg	 Kg/	 hp	€
ESPALTRACT	1060	3000	240	400	35-55	1.530 €

POLIDOZERS

Lame Niveleuse / Pá Niveladora / Polidozer

Referencia	 mm	Kg	 mm	 hp	€
ES71519	1200x1370x950	70	1.200	18-25	295 €
ES71520	1500x1370x950	79	1.500	20-35	332 €
ES71521	1500x1370x950	84	1.800	25-40	388 €

Referencia	 mm	Kg	 mm	 hp	€
ESPOL2550Z	1800x1370x1050	240	1.800	60-80	750 €



ESPOL2550Z
Cuchilla trasera
15 mm de espesor.
Cuchilla giratoria 360°

NOVEDAD

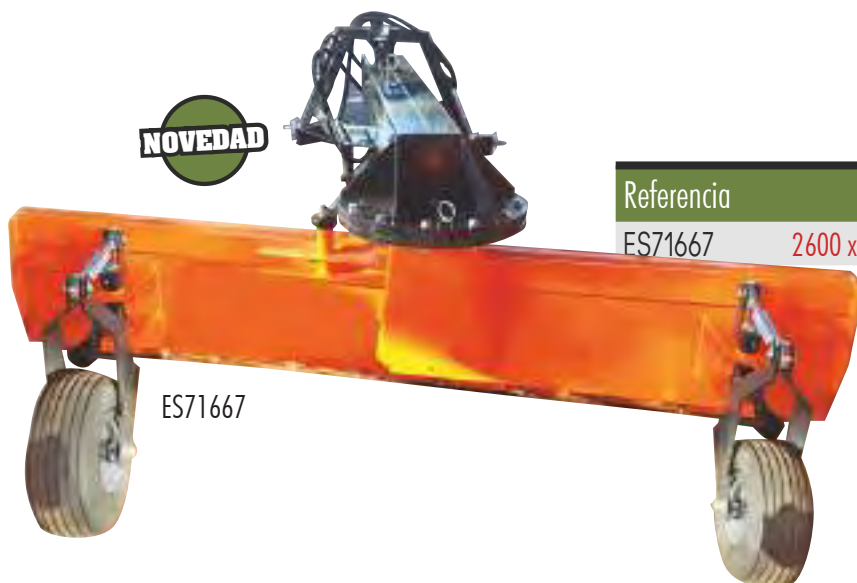

ES71667

Referencia	 mm	Kg	 mm	 hp	€
ES71667	2600 x 1975 x 1295	430	2.500	60-80	2.710 €

Cambio de ángulo hidráulico

IMPLEMENTOS DE CULTIVO DE PATATAS PARA TRACTOR

Plantadoras de patatas

Planteuses de pommes de terre à 2 rangées / Plantadores de batata 2 linhas / Two rows potato planters

2 FILAS



ES70557

Canal
Zeppelin
Maquinaria

Permiten siembra a partir de patatas enteras o cortadas. Fácil ajuste de la dosis de plantación.
Rejas abresurcos regulables en altura.
Tolva de gran capacidad con facilidad de carga.

Pour planter des pommes de terre entières ou coupées.
Roues de réglage facile pour adapter la distance de plantation.
Socs réglables en hauteur.
Trémie de grande capacité et charge facile.



ES70557

For planting of whole or cutted potatoes.
Easy adjustment wheels to adapt the planting distance.
Height adjustable plow.
High capacity hopper and easy load.

Permitem semear batatas inteiras ou cortadas.
Fácil ajuste da quantidade a plantar
Sulcos de abertura ajustável em altura.
Depósito de grande capacidade com carregamento fácil.



Abonadora opcional.

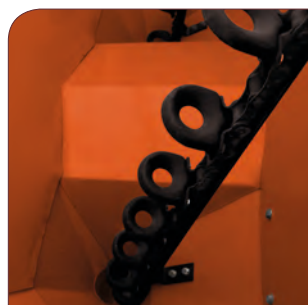

Detalle cadena de transporte.

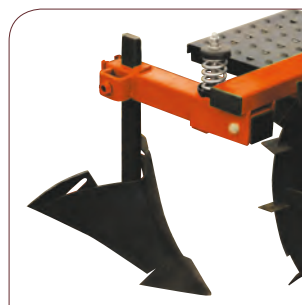

Ajustable en altura.



Ruedas de goma opcionales.

Referencia	 Cat.	Kg/	mm	mm	ABONADORA ÉPANDÉUR FERTILIZER	RUEDA ROUE RODA	€
ES70557	2º	180	625/675	100-150	no	METAL	1.234 €
ES70687	2º	180	625/675	100-150	si	METAL	1.402 €
ES70691	2º	180	625/675	100-150	no	GOMA	1.276 €
ES70728	2º	180	625/675	100-150	si	GOMA	1.471 €
ES70676	2º	300	700/750	100-150	no	METAL	1.649 €
ES70688	2º	300	700/750	100-150	si	METAL	1.844 €
ES70729	2º	300	700/750	100-150	no	GOMA	1.779 €
ES70730	2º	300	700/750	100-150	si	GOMA	1.973 €

IMPLEMENTOS DE CULTIVO DE PATATAS PARA TRACTOR

Plantadoras de patatas

Planteuse de pommes de terre à une rangée / Plantadores de batata uma linha / One row potato planter

1 FILA



ES70780
RUEDA GOMA

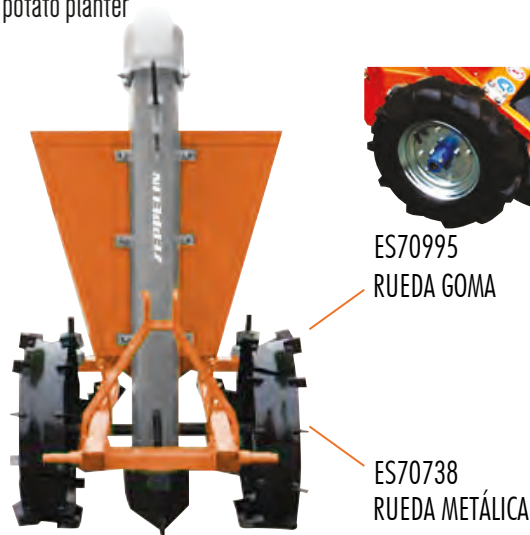

- Permiten siembra a partir de patatas enteras o cortadas.
Tolva con facilidad de carga. Fácil ajuste de la dosis de plantación. Rejas abresurcos regulables en altura.
- Pour planter des pommes de terre entières ou coupées.
Roues de réglage facile pour adapter la distance de plantation. Socs réglables en hauteur. Trémie de grande capacité et charge facile.



ES70995
RUEDA GOMA

ES70738
RUEDA METÁLICA

- For planting of whole or cutted potatoes.
Easy adjustment wheels to adapt the planting distance.
Height adjustable plow. High capacity hopper and easy load.
- Permitem semente batatas inteiras ou cortadas.
Depósito de fácil carregamento. Fácil ajuste da quantidade a plantar. Sulcos de abertura ajustável em altura.

Referencia	 Cat.	Kg/	 mm	 mm	ABONADORA ÉPANDEUR FERTILIZER	RUEDA ROUE RODA	€
ES70738	1º	90	625/725	100-150	no	METAL	914 €
ES70995	1º	90	625/725	100-150	no	GOMA	954 €
ES70780	1º	30	500	60-120	no	GOMA	752 €

Arrancapatatas

Arracheuses de pommes de terre / Arrancadores de Batatas / Potato diggers



ESAP001

Canal
Zeppelin
Maquinaria





ES70662

SALIDA LATERAL

- Apero para recolectar todo tipo de tubérculos.
Sistema de vibración por excéntrica. 1 fila de recolección.
Regulación de altura y profundidad de trabajo.
- Machine pour collecter les tubercules.
Système de vibration par excentrique. Récolte d'une rangée.
Réglage en hauteur et profondeur de travail.

- Machine for collecting tubers.
Vibrancy system by eccentric. Single row collection.
Height and working depth adjustment.
- Máquina para recolha de todos os tipos de tubérculos.
Sistema de vibração excêntrica. Colheita de 1 linha
Regulação da altura e profundidade do trabalho.

Referencia		Kg	 mm	 hp	€
ESAP001	1 fila / 1 rangée / 1 linha / 1 row	175	500	20	929 €
ES70662	1 fila salida lateral / 1 rangée sortie latéral / 1 linha saída lateral / 1 side lateral output	200	675	25	1.827 €

ABONADORAS A TOMA DE FUERZA PARA TRACTOR

Abonadora monodisco de polietileno

Épandeurs à disque en polyéthylène / Distribuidores de Adubo de um disco em polietileno

/ One disc fertilizer spreaders made of polyethylene

500
Kg



ESABON500PLA-H

Con apertura y cierre hidráulico.

Cardan no incluido

+150
Kg

Acople cónico de suplemento de capacidad



ESABON500PL-SUP

Localizador doble



ESLOCDOBLEPL

Subsolador un brazo con tubo dosificador



ESSUBSJ15-AB

Abonadoras monodisco con tolva en polietileno de alta resistencia. Plato difusor en acero inoxidable. Agitador antigrumos.

Épandeur à disque unique. Trémie fabriquée en polyéthylène de haute résistance. Disque diffuseur en acier inoxydable. Agitateur pour éviter les grumeaux d'engrais.

Distribuidor de adubo de disco único com tremonha em polietileno de alta resistência. Disco em aço inoxidável. Com Agitador.

One disc fertilizer spreader. Hopper made of high strength polyethylene. Stainless steel diffuser disc. Agitator to avoid fertilizer clumps.

Abonadoras monodisco

Referencia	↔ mts	⊙ rpm	√ Kg/	Apertura /Ouverture /Opening	Localizador / Localisateur / Locator	Kg	€
ESABON500PLA	6-14	540	500	MECÁNICA	Simple	68	510 €
ESABON500PLA-H	6-14	540	500	HIDRÁULICA	Simple	71	670 €
ESABON500PL-LA	6-14	540	500	MECÁNICA	Doble / Double	70	671 €
ESABON500PLA-HL	6-14	540	500	HIDRÁULICA	Doble / Double	73	777 €

Accesorios

Referencia	✎	€
ESABON500PL-SUP	Suplemento de capacidad 150 kg. / Capacité supplémentaire de 150 kg. / Supplement capacity 150 kg.	113 €
ESLOCDOBLEPL	LOCALIZADOR DOBLE de plástico suelto. / Double localisateur en plastique / Plastic double locator	166 €
ESSUBSJ15-AB	Subsolador una hilera / Sous-soleuses / Subsoilers	2.154 €

ABONADORAS A TOMA DE FUERZA PARA TRACTOR

Abonadoras monodisco de metal.

Épandeurs à disque métallique / Distribuidores de adubo de um disco em metal / Metallic One disc fertilizer spreaders



Con apertura manual.
Cardan no incluido.

- Abonadoras monodisco con tolva en metal. ■ One disc fertilizer spreader. Hopper made of metal. Stainless steel diffuser disc. Agitador antigromos. Agitator to avoid fertilizer clumps.
- Épandeur à disque unique. Trémie fabriquée en métal. Disque diffuseur en acier inoxydable. Agitateur pour éviter les grumeaux d'engrais. ■ Distribuidor de adubo de disco único com Tremonha em metal. Disco em aço inoxidável. Agitador.

Referencia	mts	rpm	Kg/		Kg	€
57490	6-14	540	500	Metal/ Métal	63	494 €
ESABON650M	6-14	540	650	Metal/ Métal	81	791 €
ESABON650M-SUP	Suplemento de 150 kg. / Supplément de 150 kg. / Supplement 150 kg.				149	€



Abonadoras pendulares €€

Épandeurs pendulaires / Distribuidores Pendulares / Pendulum fertilizer spreaders



Chasis y grupo reforzado.
Cardan incluido.
ESABONPE1000H

TIPO DE GRUPO VICON



Referencia	mm	mts	Kg/	lts/	Kg	€
ESABONPE1000	1070x1360x1900	14	1300	1000	158	2.415 €
ESABONPE1000H	1070x1360x1900	14	1300	1000	158	2.825 €
ESABONPE1200	1170x1360x1900	14	1500	1200	160	2.615 €
ESABONPE1200H	1170x1360x1900	14	1500	1200	160	2.605 €

MODELOS H: APERTURA HIDRÁULICA

Abonadoras de dos platos €€

Épandeurs à deux disques / Distribuidor de Adubo de dois discos. / Double disc fertilizer spreaders

ESABON1200MDD

Doble disco centrífugo e inoxidable. Apertura hidráulica. Cardan no incluido.



Dosificador abonadora
Ref.: 89270 - 189 €

150/200 kg/min.

Referencia	mm	mts	rpm	m³	Kg	€
ESABON1000MDD	1550X1430X1420	8-16	540	1,05	195	2.720 €
ESABON1200MDD	1550X1430X1640	8-16	540	1,30	245	2.888 €



FORRAJE**Pinzas Carga Pacas**

Pinces à balles / Pinças para Fardos / Bale grabbers

Pinza carga pacas.
Enganche tipo EURO.Grabber for round bales.
EURO hitch type.Pince à balles rondes.
Type d'attelage EURO.Pinças para Fardos
Engate tipo EURO.

Referencia	 mm	Kg	(kg)	 mm	 hp	€
ES70725	1500X1400x750	160	800	1500	40	992 €

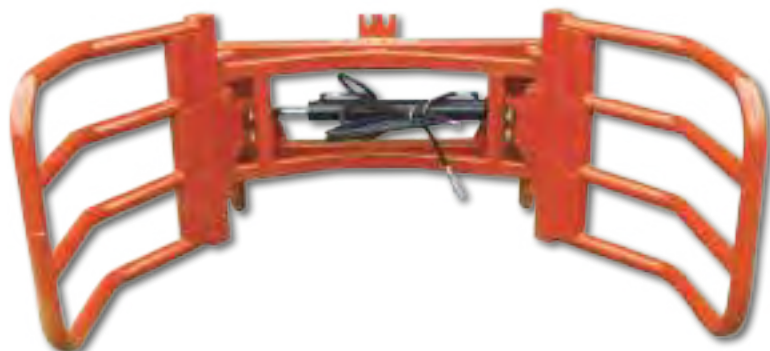

Referencia	 mm	Kg	(kg)	 mm	 hp	€
ES70535	1340 x 1350 x 750	160	900	1445	40	1.213 €

**ENGANCHES
TIPO
EURO**

Referencia	 mm	Kg	(kg)	 mm	 hp	€
ES70536	1400x1450x800	200	1200	2000	40	1.370 €

FORRAJE

Cazos

Chargeurs à fourche / Baldes Carregadores / Buckets





Diseñada para trabajar con pala frontal gracias al enganche tipo Euro.

Enganche tipo **EURO**



Cazo cargador estiércol





Godet à fourche / Balde Carregador com Forquilha / Bucket

Referencia	 mm	 m³	 Kg	 m³	 Kg	 Cilindro Cylinder Cylindre	€
ES70545	1500	800	830	1.00	280	2	1.271 €
ES70538	1800	950	1000	1.2	310	2	1.433 €
ES70546	2000	1100	1110	1.33	340	2	1.848 €

Pinzas desenfilado



Fourche double / Forquilha Hidráulica / Manure fork

Referencia	 mm	 Kg	 nº	 Kg	 Cilindro Cylinder Cylindre	€
ES70547	1500	650	7/7	200	2	1.381 €
ES70548	1800	800	8/8	230	2	1.538 €
ES70549	2000	1000	9/9	270	2	1.738 €

Cargadora estiércol



Fourche / Forquilha de estrume / Manure loader

Referencia	 mm	 Kg	 Kg	 nº	€
ES70542	1500	650	110	7	593 €
ES70543	1800	800	150	8	714 €
ES70544	2000	950	180	9	835 €

Cargador Frontal

Front Loader / Chargeur avant / Carregador frontal

Referencia	 mm	 mm	 Kg	 Kg	€
ES70539	1240	1020	1600	180	772 €

FORRAJE

Cazos

Godets / Baldes para limpieza / Buckets



Enganche tipo EURO

Cazos para áridos

Buckets / Godets / Baldes para limpieza

Referencia	mm	Kg	m ³	m ³	Kg	€
ES70552	1500	800	0.48	0,58	164	698 €
ES70553	1800	950	0.57	0,68	194	730 €
ES70554	2000	1050	0.64	0,77	207	772 €
ES70555	2200	1150	0.70	0,84	225	908 €
ES70556	2400	1250	0.76	0.91	243	971 €

Cazos cargador tipo MANITOU

Godets / Baldes Carregador tipo MANITOU / Buckets



Laterales desmontables.
Función antiderrame.
Cucharón de dientes reforzados.



Removable sides.
Anti-spill function.
Reinforced bucket teeth.



Côtés amovibles.
Fonction anti-déversement.
Godet à dents renforcé.



Laterais removíveis.
Função anti-derrame.
Balde de dentes reforçados.

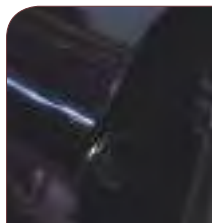

Enganche tipo MANITOU

Referencia	mm	Kg	m ³	Kg	€
ES70879	1800	900	1,00	510	3.171 €
ES70880	2000	1.100	1,11	530	3.276 €
ES70881	2300	1.250	1,26	570	3.384 €

Transportador pacas

Transporteur de balles / Transportador de Fardos / Bale transporter



Transportador de pacas.
Modelo simple.



Bale transporter.
Standard model.



Transporteur de balles.
Modèle simple.



Transportador de fardos.
Modelo simples

Referencia	mm	mm	Kg	€
ES70540	460 x 1100	1200	90	677 €



Enganche tipo EURO



ELEVADORES HIDRAULICOS PARA TRACTOR

Élévateurs / Elevadores de tractor / Tractor forklifts

- Movimiento elevación de la carga. Desplazamiento lateral.
- | Inclinación en sentido longitudinal de todo el conjunto elevador.
- ■ Mouvement de levage de la charge. Déplacement latéral.
- | Inclinaison longitudinale de l'ensemble de l'élévateur.

- Lifting movement of the load.
- | Lateral displacement
- | Longitudinal inclination of the entire forklift.
- Levantamento de movimento da carga.
- | Deslocamento lateral. Inclinação na direção longitudinal de todo o conjunto de elevação

DUPLEX

2 Alturas









TRIPLEX

3 Alturas



Control hidráulico de la ES70697

Referencia	 mm	 Kg	Kg	 mm	€
ES70580	3200	1700	415	720x1530x2420	3.686 €

Referencia	 mm	 Kg	Kg	 mm	€
ES70697	3200	1500	450	720x1530x1900	4.517 €



Prensa opcional para todos los modelos.

Presse optionnel / Prensa opcional para todos os modelos / Tractor forklifts

Referencia	Kg	€
ESPRELEV-01Z	50	625€

ELEVADORES MECANICOS PARA TRACTOR

Cargadora al tripuntal

Levè-palettes / Porta Paletes aos 3 Pontos / Pallet loaders



ES70618

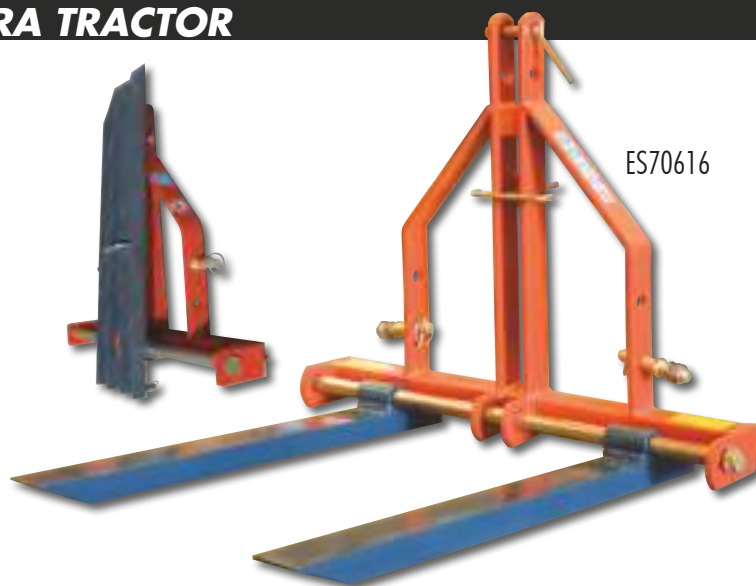

ES70616

Plegable para su transporte / Pliable / Foldable / Dobrável

Referencia	hp	Kg	Kg	€
ES70616	15-30	300	45	284 €
ES70617	30-60	700	60	450 €
ES70618	20-60	1200	90	515 €

ASTILLADORAS HIDRÁULICAS Y A TOMA DE FUERZA PARA TRACTOR

Fendeuses de Büches / Rachadores para o trator. / Log Splitters

22 TN H



ESASTTR01Z

Fuerza de corte 22 TN
Ciclo de corte 16s
Disposición Horizontal/Vertical
Potencia mínima: 15 hp
Peso: 220 Kg.
Dimensiones: 1940x490x1300 mm.

1.843 €

BASE REGULABLE 3 POSICIONES



Tripuntal y soporte para trabajo
HORIZONTAL y VERTICAL

22 TN F



ESASTTR03Z

Fuerza de corte 22 TN
Ciclo de corte 16s
Disposición V
Potencia mínima: 15 hp
Peso: 266 Kg.
Dimensiones: 1940x490x1300 mm.
A Cardan y bomba hidráulica.

2.098 €



Equipo hidráulico
independiente.

ASTILLADORAS A TOMA DE FUERZA PARA TRACTOR

Log Splitters / Fendeuses de Bûches / Rachadores para o trator.

14 **TN**



ESASTTR09Z

Fuerza de corte 14 TN
Ciclo de corte: según HP tractor.
Disposición Horizontal
Potencia mínima: 18 hp
Peso: 114 Kg.
Dimensiones: 1855x800x750 mm.

692 €



15 **TN**



ESASTTR12Z

Fuerza de corte 14 TN
Ciclo de corte: según HP tractor.
Disposición Vertical
Potencia mínima: 18 hp
Peso: 141 Kg.
Dimensiones: 640x595x1890 mm.

820 €



Ver vídeo Canal Zeppelin Maquinaria

ASTILLADORAS DE MOTOR GASOLINA

Fendeuses thermiques / Rachadores com motor a gasolina / Log Splitters with engine

22 **TN**



hp Gasolina

6.5HP

OHV



Posición horizontal

ESASTTR02ZN

Fuerza de corte 22 TN
Motor: 208 cc.
Ciclo de corte 14,5s
Disposición Horizontal / Vertical
Peso: 206 Kg.
Dimensiones: 1870x505x680 mm.

1.229 €



Posición vertical

ASTILLADORAS DE MOTOR GASOLINA

Fendeuses thermiques / Rachadores com motor a gasolina / Log Splitters with engine

22 TN



hp **Gasolina**

6.5HP

FASE V
MOTOR

MOTOR: **LONCIN**



Posición Horizontal



Posición vertical

ESASTTR08Z

Fuerza de corte 22 TN
Motor: 208 cc.
Ciclo de corte 15s
Disposición Horizontal / Vertical
Peso: 225 Kg.
Dimensiones: 2280x1220x1190 mm.
Diámetro rueda: 16"

1.574 €

35 TN OHV



hp **Gasolina**

13HP

FASE V
MOTOR

MOTOR: **LONCIN**

OHV

Posición vertical



Posición Horizontal



4 LADOS
4 WAY WEDGE
4 COINS

ESASTTR05ZN

Fuerza de corte 35 TN
Motor: 390 cc.
Ciclo de corte 13.5s
Disposición Horizontal / Vertical
Peso: 311 Kg.
Dimensiones: 2287x1311x1240 mm.
Diámetro rueda: 16"

2.182 €

CUÑA INCLUIDA



Mandos.



Luces con conexión.

BIOTRITURADORAS A TOMA DE FUERZA PARA TRACTOR

Broyeurs de branches / Biotrituradoras para tractor / Wood chippers

3018Z

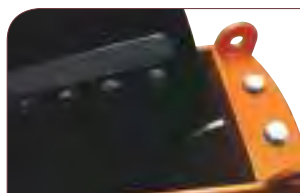

Cuchillas.



Giro 360°.

3020Z



Salida regulable.

Alimentación manual.

Tritura madera (troncos, ramas) y plantas leñosas (setos, arbustos, etc.). Chimenea de salida regulable.

Alimentation manuelle.

Broyage de bois (troncs, branches) et des plantes ligneuses (haies, buissons, etc...). Goulotte réglable

Manual feed.

Wood chipping (logs, branches) and woody plants (hedges, bushes, etc...). Discharge chute adjustable.

Alimentação manual

Tritura madeira (troncos, ramos) e plantas lenhosas (sebes, arbustos, etc.). Chaminé de saída ajustável.

Referencia	mm	Kg	mm			PTO r/min	hp	€
ESTRF3018Z	1016x1066x1525	195	100	no	4	540/1.000	18-35	1.313 €
ESTRF3020Z	1630x840x1240	180	130	no	2	540	20-30	1.502 €
ESTRF3018Z-TOLV	Alargador tolva 140 cm /Rallonge de trémie 140 cm /Hopper extension 140 cm							79 €

BIOTRITURADORAS A TOMA DE FUERZA PARA TRACTOR

Broyeurs de branches / Biotrituradoras para tractor / Wood chippers

3055 Z

Ø 16
GM



Rodillo alimentador.

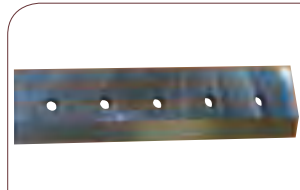

Cuchillas.



ESTRF3055Z

3045 Z

Ø 18
GM

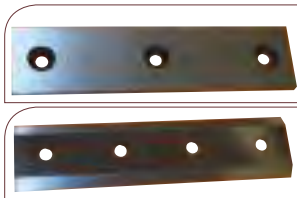

Cuchillas.



Rodillo alimentador.



ESTRF3045Z

Alimentación manual.

Tritura madera (troncos, ramas) y plantas leñosas (setas, arbustos, etc.).
Rodillos de alimentación hidráulico hidráulico (circuito independiente).
Chimenea de salida regulable.

Alimentation manuelle.

Broyage de bois (troncs, branches) et des plantes ligneuses (haies, buissons, etc...). Rouleaux d'alimentation hydrauliques hydrauliques (circuit indépendant). Goulotte réglable.

Manual feed.

Wood chipping (logs, branches) and woody plants (hedges, bushes, etc...).
Hydraulic hydraulic feed rollers (independent circuit). Discharge chute adjustable.

Alimentação manual.

Tritura madeira (troncos, ramos) e plantas lenhosas (sebes, arbustos, etc.).
Rolos hidráulicos de alimentação hidráulica (circuito independente). Chaminé de saída ajustável.

Referencia	mm	Kg	Ø mm			PTO r/min	hp	€
ESTRF3045Z	2320x1400x1620	440	180	si	2	540	30-45	2.620 €
ESTRF3055Z	2150x1450x1850	330	160	si	2	540	30-55	2.074 €

BIOTRITURADORAS A TOMA DE FUERZA PARA TRACTOR

Broyeurs de branches / Biotrituradoras para tractor - hidráulica Wood chippers

3080 Z

Ø 13
GM

Tractor
Hidráulica

360°

Ver vídeo Canal Zeppelin Maquinaria



Base ajustable.



2 Rodillo + Cuchilla fija



Disco giratorio con 4 Cuchillas.



Chimenea de salida regulable 360°.



Chimenea de salida regulable.



Palanca cambio sentido triturado.

ES Alimentación manual.
Tritura madera (troncos, ramas) y plantas leñosas (setos, arbustos, etc.).
Rodillos de alimentación hidráulicos. Chimenea de salida regulable.
Palanca cambio sentido triturado.

FR Alimentation manuelle.
Broyage de bois (troncs, branches) et des plantes ligneuses (haies, buissons, etc...). Rouleau d'alimentation hydraulique. Goulotte réglable. Manette 3 positions (avant, arrière, arrêt) de rouleau d'alimentation.

EN Manual feed.
Wood chipping (logs, branches) and woody plants (hedges, bushes, etc...)
Hydraulic feeding roller. Discharge chute adjustable.
3 position lever (forward, backward, stop) of the feeding roller.

PT Alimentação manual.
Tritura madeira (troncos, ramos) e plantas lenhosas (sebes, arbustos, etc.).
Rolos de alimentação hidráulicos. Chaminé de saída ajustável.
Alavanca de controlo de direção.

Referencia	mm	Kg	Ø mm	si	4 + 1	PTO r/min	hp	€
ESTRF3080Z	2040x1710x1880	370	130	si	4 + 1	540	40-45	3.660 €

BIOTRITURADORAS A TOMA DE FUERZA HIDRÁULICA

Broyeurs de branches hydrauliques / Biotrituradoras para tractor - hidráulica / Hydraulic Wood chippers

30100Z



Ø mínimo para autoalimentador
5 cm.



4 Cuchillas.



Rodillos hidráulicos.



- Alimentación manual.
Tritura madera (troncos, ramas) y plantas leñosas (setos, arbustos, etc.).
Rodillos de alimentación hidráulicos. Chimenea de salida regulable.
- Alimentation manuelle.
Broyage de bois (troncs, branches) et des plantes ligneuses (haies, buissons, etc.).
Rouleau d'alimentation hydraulique. Goulotte réglable.

- Manual feed.
Wood chipping (logs, branches) and woody plants (hedges, bushes, etc.).
Hydraulic feeding roller. Discharge chute adjustable.
- Alimentação manual.
Tritura madeira (troncos, ramos) e plantas lenhosas (sebes, arbustos, etc.).
Rolos de alimentação hidráulicos. Chaminé de saída ajustável.
Alavanca de controlo de direção.

Referencia	mm	Kg	mm			PTO r/min	hp	€
ESTRF30100Z	1270x1320x1879	448	150	si	4	540	30-100	4.043 €

BIOTRITURADORAS A TOMA DE FUERZA HIDRÁULICA

Broyeurs de branches hydrauliques / Biotrituradoras para tractor - hidráulica / Hydraulic Wood chippers

65100Z

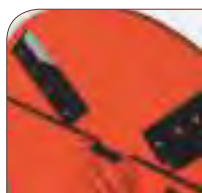

4 Cuchillas.



Rodillos hidráulicos.



Ø mínimo para autoalimentador 5 cm.



Referencia	mm	Kg	Ø mm			PTO r/min	hp	€
ESTRF65100Z	1320x1270x2286	625	250	si	4	540	65-100	5.859 €



90120Z



LA MÁS GRANDE DE ZEPPELIN al tractor



ES Entrada: 43 x 25 cm.
Tritura madera (troncos, ramas) y plantas leñosas (setos, arbustos, etc.). Rodillos de alimentación hidráulicos. Chimenea de salida regulable.

FR Entrée: 43 x 25 cm.
Broyage de bois (troncs, branches) et des plantes ligneuses (haies, buissons, etc.). Rouleau d'alimentation hydraulique. Goulotte réglable.

DK Input: 43 x 25 cm.
Wood chipping (logs, branches) and woody plants (hedges, bushes, etc.). Hydraulic feeding roller. Discharge chute adjustable.

PT Entrada: 43 x 25 cm.
Tritura madeira (troncos, ramos) e plantas lenhosas (sebes, arbustos, etc.). Rolos de alimentação hidráulicos. Chaminé de saída ajustável. Alavanca de controlo de direção.

Referencia	mm	Kg	Ø mm			PTO r/min	hp	€
ESTRF90120Z	2530x1550x2680	910	250	si	4	1000	90-120	6.280 €

BIOTRITURADORAS A MOTOR GASOLINA

Broyeurs de branches à essence / Biotrituradoras com motor a gasolina / Gasoline engine wood chipper



15HP

hp Gasolina

FASE
MOTOR

**Boton de parada de
emergencia.
ARRANQUE ELÉCTRICO**

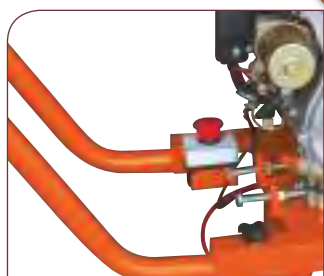

Referencia	mm	Kg	mm	hp	€	
ES70722	2310X1500X800	171	100	2fijas	15	1.950 €

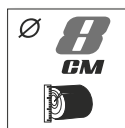

6.5HP

hp Gasolina

LONCIN
OHV

EFICIENCIA DE
TRABAJO:

4m³/hora



Motor de Gasolina LONCIN



Hasta 8 cm.



Referencia	mm	Kg	mm	hp	€	
ES71609	1800X625X1250	90	80	2+1	6.5	1.125 €

BIOTRITURADORAS A MOTOR GASOLINA

Gasoline engine wood chipper / Broyeurs de branches à essence / Biotrituradoras com motor a gasolina

31 HP

hp Gasolina



FASE MOTOR

NOVEDAD



EFICIENCIA DE TRABAJO:
10m³/hora



REMOLQUE INCLUIDO



Motor de Gasolina
BRIGGS & STRATTON



2 Cuchillas giratorias.



Rodillo más cuchilla fija
ALTURA DE DESCARGA
2000 mm



Referencia	mm	HP	hp	Kg	Ø mm	mm	rpm	€
ES71628	3400x1300x2270	31	4 tiempos	870	152	2 +1 fija	1.700	9.890 €

BIOTRITURADORAS A MOTOR DIESEL

Biotrituradora con motor diesel 40HP

Diesel engine wood chipper / Broyeur de branches diesel /
Biotrituradoras com motor a diesel



40HP



Biotrituradora con remolque no homologado ES70597

EFICIENCIA DE
TRABAJO:

12 m³/hora



Biotrituradora sin remolque ES70597NZ

Remolque ES70597R.

Homologado:

Referencia	mm ³ bitrituradora	HP	hp	Kg	Ø mm	mm	mm	rpm	€	REMOLQUE ADAPTADO
ES70597	1900x1110x1200	40	4 tiempos	700	200	2 + 1 fija	2000	1.280	7.980 €	Referencia €
ES70597NZ	1900x1110x1200	40	4 tiempos	600	200	2 + 1 fija	2000	1.280	7.002 €	ES70597R 1.526 €

ATOMIZADORES A TOMA DE FUERZA



Atomizador arrastrado 2000L

Towed atomizer / Atomiseur tracté/ Atomizador rebocáve



RUEDA 10.0/75-15,3 12PR
 ESATOM1000 DIÁMETRO VENTILADOR 800 MM. (1.000 L)
 ESATOM2000ST DIÁMETRO VENTILADOR 820 MM. (2.000 L)
 ES71671 DIÁMETRO VENTILADOR 920 MM. (2.000 L)

RUEDA 400/60-15,5 14PR
 ESATOM2000JA DIÁMETRO VENTILADOR 820 MM. (2.000 L)
 ES71672 DIÁMETRO VENTILADOR 920 MM. (2.000 L)



Nivel y lavamanos



Grupo y bomba



Boquilla antigoteo.

**Opcional
Kit Electroválvula
y Sonar**
*A consultar

Equipo herbicida e insecticida con bomba de diafragma. Boquilla doble de latón antigoteo.
 | Tanque de lavado de manos. Tanque de lavado de circuitos.

Herbicide and insecticide equipment with diaphragm pump. Double nozzle made of non-drip brass. Hand wash tank. Tank washing circuits.

Matériel pour herbicides et insecticides avec pompe à membrane. Double buse en laiton anti-goutte, réservoir lave-mains / lave circuit.

Equipamento para herbicida e inseticida com bomba de diafragma. Duplo jato Antigota de Latão. Limpa circuitos. Lava mãos.

Referencia	hp	[lts]	Turbina	Vel.	l/min	mts	boquillas nozzles buses	bar	Kg	⊗	↕ mm	€
ESATOM1000	35	1000	820	1	125	≥10	10	0-40	428	10.0/75 15.3 12PR	2360 x 1370 x 1460	6.890 €
ESATOM2000ST	50	2000	820	1	125	≥10	12	0-40	635	10.0/75 15.3 12PR	3490 x 1490 x 1670	8.320 €
ESATOM2000JA	50	2000	820	1	125	≥10	12	0-40	635	400/60 15.5 14PR	3490 x 1910 x 1695	9.090 €
ES71671	50	2000	920	2	125	≥10	12	0-40	635	10.0/75 15.3 12PR	3490 x 1490 x 1670	8.920 €
ES71672	50	2000	920	2	125	≥10	12	0-40	635	400/60 15.5 14PR	3490 x 1910 x 1695	9.690 €

PULVERIZADORES SUSPENDIDOS A TOMA DE FUERZA

Atomizadores suspendidos

Atomizers / Atomiseurs / Atomizadores suspensos



Ver vídeo
Canal
Zeppelin
Maquinaria

ES Depósito en polietileno de alta Resistencia. Chasis galvanizado. Hélice 720. Depósito lavacircuitos / lavamanos. Ideal para frutales y olivar. Filtro de aspiración con válvula de retención. Indicador de nivel exterior transparente. Boquilla doble anti goteo de latón. Regulador de presión.

FR Réservoir en polyéthylène de haute résistance. Châssis galvanisé. Hélice 720. Réservoir lave-mains / lave circuit. Idéal pour les arbres fruitiers et des les oliviers. Filtre d'aspiration avec valve anti-retour. Indicateur de niveau extérieur transparent. Buse anti égouttement en laiton. Régulateur de pression.

EN High resistance polyethylene tank. Galvanized chassis. Helix 720. Hand wash / Circuit wash tank. Ideal for fruit trees and olive groves. Suction filter with non-return valve. Transparent external level indicator. Non-dripping nozzle made of brass. Pressure regulator.

PT Depósito em polietileno de alta resistência. Chassi galvanizado. Hélice 720. Reservatório de lava circuitos / lava mãos. Ideal para árvores fruto, vinha e olivais. Filtro de sucção com válvula de retenção. Indicador de nível externo transparente. Jatos duplo anti gota. Regulador de pressão.



Deflector de aire.

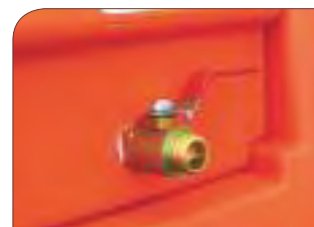

Depósito lavamanos.



Boquilla antigoteo.



Bomba de membranas.

Referencia	hp	lts	l/min	X mts	Ømm.	boquillas nozzles buses	bar	Kg	mm	€
ES70632	35	300	80	>5	700	10	50	190	1300 x 1000 x 1265	2.690 €
ES70965	40	400	80	>5	700	10	50	210	1350 x 1200 x 1220	2.790 €
*ES70633L	50	600	80	>5	800	10	50	266	1490 x 1360 x 1360	3.085 €
*ES70634L	75	800	80	>5	800	10	50	293	1515 x 1360 x 1600	3.630 €

* Ventilador diámetro: 800 mm.

www.zeppelinmaquinaria.es

PULVERIZADORES A TOMA DE FUERZA

Pulverizadoras suspendidas con barras

Sprayer with booms / Pulvérisateurs avec des rampes / Pulverizadores suspensos com barras



Canal Zeppelin Maquinaria

ESPUL1200B15MHH
Cardan no incluido.

ES Depósito en polietileno de alta Resistencia. Chasis pintado al polvo y horno. Depósitos auxiliares mezclador y lavamanos (Opcional). Boquillas simples y triples según modelo. Regulación de presión y corte por tramos. Bomba de membranas.

DK High resistance polyethylene tank. Chassis with oven baked powder paint. Auxiliary washing hands and mixer tank (Optional). Single and double nozzles depending on the model. Pressure regulation and cutting by sections. Diaphragm pump.

FR Réservoir en polyéthylène de haute résistance. Châssis avec la peinture en poudre au four. Réservoirs auxiliaires lave-mains et mélangeur (En option). Buses simples et doubles selon le modèle. Réglage de pression et coupe par sections. Pompe à membranes.

PT Depósito em polietileno de alta resistência. Chassis pintados. Misturador auxiliar e depósito lava mãos (Opcional). Jatos simples e triplos de acordo com o modelo. Regulação da pressão e corte por seções. Bomba de membrana.



Triple boquilla opcional.



ESPUL1200B15MHH Apertura hidráulica.

Referencia	lts	l/min	mts	boquillas nozzles buses		€
ESPUL200B4M	200	90	4	20	Con barra / With boom / Avec rampe / Com barra	1.185 €
ESPUL450B10M	450	90	10	20	Con barra / With boom / Avec rampe / Com barra	1.410 €
ESPUL600B10M	600	90	10	20	Con barra / With boom / Avec rampe / Com barra	1.850 €
ESPUL600B12M	600	90	12	24	Con barra / With boom / Avec rampe / Com barra	1.885 €
ESPUL800B10M	800	100	10	20	Con barra / With boom / Avec rampe / Com barra	1.990 €
ESPUL800B12M	800	100	12	24	Con barra / With boom / Avec rampe / Com barra	2.030 €
ESPUL800B12MH	800	100	12	25	Estabilizador y elevación hidráulica de barra/ Stabilizer and hydraulic boom/Rampe Stabilisatrice et hydraulique/ Estabilizador e barra de elevação hidráulica	3.790 €
ESPUL1000B10M	1000	100	10	20	Con barra / With boom / Avec rampe / Com barra	2.137 €
ESPUL1000B12M	1000	100	12	24	Con barra / With boom / Avec rampe / Com barra	2.148 €
ESPUL1000B14M	1000	100	14/15	28/30	Estabilizador de barra/ Stabilizer boom/ Barre Stabilisatrice/ Estabilizador e barra	2.943 €
ESPUL1000B14MH	1000	100	14/15	28/30	Estabilizador y elevación hidráulica de barra/ Stabilizer and hydraulic boom/Rampe Stabilisatrice et hydraulique/ Estabilizador e barra de elevação hidráulica	5.770 €
ESPUL1200B12M	1200	100	12	28/30	Estabilizador y elevación mecánica de barra/ Stabilizer and mechanic boom/Rampe Stabilisatrice et mécanique/ Estabilizador e barra de elevação mecanica	2.585 €
ESPUL1200B15MHH	1200	100	15	28/30	Estabilizador y elevación hidráulica de barra/ Stabilizer and hydraulic boom/Rampe Stabilisatrice et hydraulique/ Estabilizador e barra de elevação hidráulica	6.355 €

PULVERIZADORES SUSPENDIDOS A TOMA DE FUERZA

Pulverizadoras suspendidas sin barras

Pulvérisateurs sans rampes / Pulverizadores suspensos sem barras / Sprayer without booms



Depósito de polietileno alta resistencia. Chasis pintado al polvo y horno.
Depósitos auxiliares mezclador y lavamanos. Bomba de membranas.

High resistance polyethylene tank. Chassis with oven baked powder paint. Auxiliary washing hands and mixer tank. Diaphragm pump.

Réservoir en polyéthylène de haute résistance. Châssis avec la peinture en poudre au four. Réservoirs auxiliaires lave-mains et mélangeur. Pompe à membranes.

Depósito de polietileno de alta resistência. Chassis pintados. Misturador auxiliar e depósito lava mãos. Bomba de membrana.

Referencia	[lts]	l/min	mts	boquillas nozzles buses		€
ESPUL200	200	90	NO	-	Sin barra / Without boom / Sans rampe	850 €
ESPUL300	300	90	NO	-	Sin barra / Without boom / Sans rampe	1.129 €
ESPUL450	450	90	NO	-	Sin barra / Without boom / Sans rampe	1.202 €
ESPUL600	600	90	NO	-	Sin barra / Without boom / Sans rampe	1.617 €
ESPUL800	800	100	NO	-	Sin barra / Without boom / Sans rampe	1.764 €
ESPUL1000	1000	100	NO	-	Sin barra / Without boom / Sans rampe	1.916 €

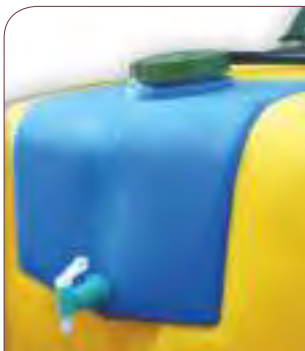

Pistola ESTURB12Z
Manguera ESTURB10M100Z



Referencia	Presión máxima	Peso	Salida	€
ESTURB12Z	50 bar	685 gr	1.5/1.8/2.0/2.5/2.8 mm	45,40 €
ESTURB10M100Z		Longitud tubo: 100 mts.		120 €

CARRETILLAS PULVERIZADORAS MOTOR 4T

Carretilla pulverizadora 100 lts

Brouette pulvérisatrice thermique / Carros de mão pulverizador / Wheelbarrow sprayer



hp Gasolina

2.5HP

100 lts



Bomba de 2 Membranas.
Caudal: 20 L/m
Presión máx.: 20 bar
Potencia: 1 hp

ESBME20Z

- Motor de 2.5 Hp de 4 Tiempos.
Depósito lavamanos y enrollador de 50 m. incluido. Ergonómica y de fácil manejo por sus 2 ruedas. Manillar desmontable.
- Moteur 2.5 HP 4 temps.
Réservoir lave-mains et enrouleur de tuyau 50 m inclus. Ergonomique et facile à utiliser grâce à ses deux roues. Guidon amovible.

- 2.5 HP 4-stroke engine.
Hand wash tank and 50 m hose roller included. Ergonomic and easy use thanks to its two wheels. Removable handlebar.
- Motor de 2,5 Hp a 4 tempos. Depósito lava mãos e enrolador incluido. Ergonómico e fácil de usar com 2 rodas. Barra de punhos removível.

Referencia	hp	[lts]	l/min	mts	Wheels	€
ESCARRPULV100ZN	2.5	100	25	50	2 METAL	790€

Carretilla pulverizadora 200 lts

Brouette pulvérisatrice thermique / Carro de mão pulverizador / Wheelbarrow sprayer



Canal Zeppelin Maquinaria



hp Gasolina

5.5HP

200 lts



ESBME30Z

Bomba de 2 Membranas.
Caudal: 35L/m
Presión máx.: 40 bar
Potencia: 3 hp

Motor 5.5 hp.



Referencia	hp	[lts]	l/min	smt	Engine Type	Wheels	€
ESCARRPULV200Z	5.5	200	30	12	SUPERTURBO	2 METAL	1.176 €

IMPLEMENTOS ATV

Trituradora ATV

ATV Flail mower / Tondo-Broyeur ATV/
Triturador ATV



MARTILLOS
ESROTATVZ y ESROTATV18HPZ



CUCHILLAS
ESROTATVZ.0

Ver vídeo
Canal
Zeppelin
Maquinaria

NOVEDAD
PORTÓN

Gasolina
hp
Arranque
Eléctrico

ESROTATV2.0



Referencia	Kg	mm	hp	€	
ESROTATVZ	230	1150	28 / --	15	1.860 €
ESROTATVZ.0	230	1150	-- / 56		1.920 €

Altura y posición de ruedas ajustable
Hauteur et position réglable
Altura e posição ajustável
Height and position adjustable

Desbrozadora ATV

ATV Topper mower / Tondeuse arrière ATV /
Capinaadeira ATV

13 HP

Gasolina
hp
Motor
4 tiempos

ES Incorporación de residuos: estiércol, restos del cultivo, hierbas.
Equipado con barras protectoras laterales.
Desplazamiento horizontal hidráulico.

FR Ajout de déchets: fumier, restes de coupe, herbes, etc...
Équipé avec des rampes de protection latérales.
Déplacement horizontal hydraulique.

GB Waste incorporation: Manure, crop residues, grass, etc...
Fitted with lateral protection rods.
Hydraulic horizontal displacement.

PT Incorporação de resíduos: estrume, resíduos de culturas, ervas.
Equipado com barras de proteção laterais.
Deslocamento horizontal hidráulico.



Referencia	mm	Kg	mm	rpm	hp	cc	PTO r/min	€	
ESSEGATVZ	1600x1270x570	210	1190	3	490	13	432	3.600	2.035 €

Rastra niveladora ATV

Herse niveleuse / Grader harrow / Escarificador nivelador ATV

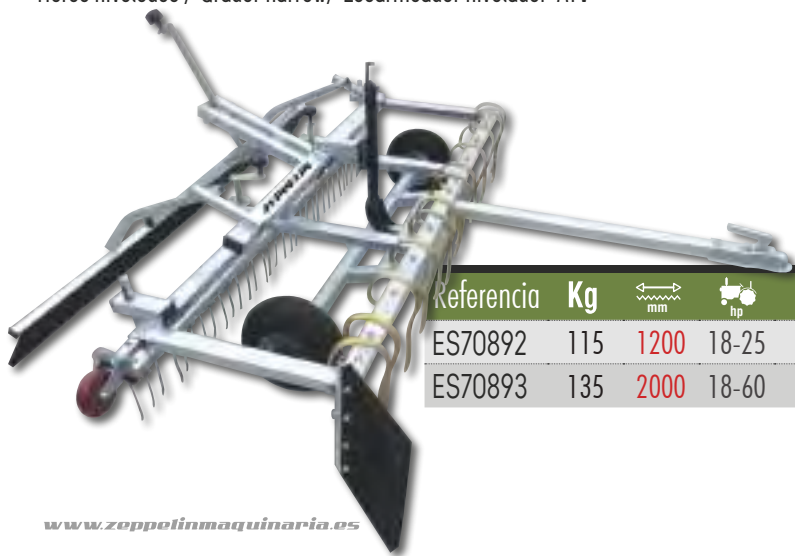

Referencia	Kg	mm	hp	€
ES70892	115	1200	18-25	1.185 €
ES70893	135	2000	18-60	1.336 €

Acople para bola de remolque ATV

Accouplement pour boule de remorquage /
3 Point linkage Towbar /
Acoplamento para bola de reboque ATV

Ajustable 3 posiciones.
Cat. 1 y 2
Galvanizado



Referencia	Kg	Kg/	hp	€
ES71522	18	2500	15-120	230 €

REMOLQUES

Remolques basculantes 2.500 kg.

Tipping trailers / Remorque basculante / Reboques basculantes



Remolque ES70611 1 EJE: Neumático 185R-14



ES70610 - ES70903

Remolque TANDEM: Neumático 20x10-8

- Portón trasero extraíble para facilitar la carga y descarga.
- Portales galvanizados de larga duración abatibles.
- Doble chasis.
- ■ Hayon arrière amovible pour faciliter le chargement et le déchargement. Portes latérales pliantes galvanisées.
- Châssis double.

- Removable tailgate for an easy loading and unloading.
- Galvanized folding side gates.
- Double chassis.
- ■ Porta traseira removível para fácil carregamento e descarregamento.
- Portas dobráveis de longa duração galvanizadas.
- Chassi duplo.

Referencia		Kg/	Kg			€
ES70611	18-50	2500	320	2	1200x2400x400	1.880 €
ES70610	18-50	2500	320	4	1200x2400x400	1.880 €
ES70903	18-50	2500	320	4	1400x2400x400	1.975 €



Remolques basculantes 4.000 kg.

Tipping trailers / Remorques basculantes / Reboques basculantes

ACABADO: Galvanizado zinc.
 EJE ADR CON FRENO
 RUEDAS: 11.5/80-15.3
 BASCULANTE: Hidráulico.



Referencia		Kg/	Kg			€
ES71538	+30	4000	950	2	1800x3000x400	3.980 €

CAJONES

Cajones de transporte

Transport boxes / Bennes portées / Caixas de transporte



ESCAJ180Z



Base reforzada.
Trampilla trasera desmontable



Base reforcée.
Hayon arrière amovible.



Reinforced base.
Removable tailgate.



Base reforçada.
Taipal traseiro removível.

Referencia	mm	Kg	°	hp	€
ESCAJ180Z	920x1800x630	150	52°	20-50	722 €

Cajones desplegados de transporte

Removable transport boxes / Bennes amovibles portées / Caixas de transporte removíveis.



Trampilla frontal y laterales
desmontables.



Trappe avant et côtés
amovibles.



Frontal and lateral
removable tailgate.



Portinhola frontal e laterais
removíveis.

Referencia	mm	Kg	Kg	hp	€
ES70612	1400	170	700	18-25	683 €
ES70613	1600	230	700	25-60	782 €
ES70614	1800	250	1000	40-80	856 €
ES70615	2000	250	1000	40-80	940 €

Plataforma de transporte

Transport platform / Plate-forme de transport / Plataforma de transporte

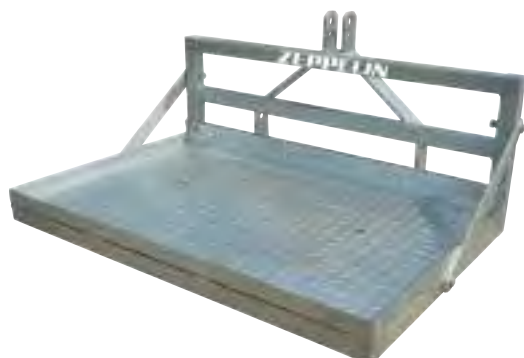

GALVANIZADAS

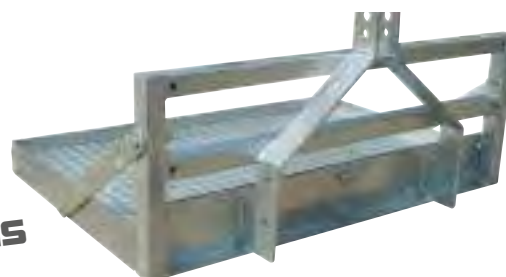

Referencia	mm	hp	Kg	€
ESCARRYALL120GZ	1200x900x640	15-40	94 Kg.	405 €
ESCARRYALL150GZ	1500x900x750	18-55	108 Kg.	454 €
ESCARRYALL180GZ	1800x1000x920	20-65	136 Kg.	637 €

EXCAVADORA COMPACTA

Miniexcavadora hidráulica autopropulsada

Mini Excavator / Micro Pelle Chenilles / Mini-escavadora hidráulica auto-propulsada

13.5 HP

hp Gasolina

mini Pincher



Mandos hidráulicos.



Motor Briggs & Stratton.



Hoja frontal niveladora.



Ver video Canal Zeppelin Maquinaria

- Estructura compacta y excelente estabilidad. Equipada con pala excavadora y frontal. Diseño ergonómico y práctico. Velocidad de desplazamiento hasta 3 km/h. Pendiente superable 30°.
- Structure compacte. Excellente stabilité. Équipé d'une pelle excavatrice avant. Design ergonomique et pratique. Vitesse de déplacement max. 3 km/h. Pente max. 30°.
- Compact structure. Excellent stability. Fitted with a front bucket. Ergonomic and practical design. Max. travel speed 3 km / h. Slope max. 30°.
- Estrutura compacta e excelente estabilidade. Equipado com balde e pá frontal. Design ergonómico e práctico. Velocidade de viagem até 3 km / h. Inclinação superável 30°.

Referencia	Alto mm	Ancho mm	Largo mm	mm ↓	mm ↓	mm ↓	°	Kg	hp	
ESEXCAV15MEZ	2000	950	1900	1320	2370	2360	360°	590	13,5	9.980 €

Cazo ESCAZO20EX15Z de 20 cm incluído.

IMPLEMENTOS



ESRIPEXCAV15Z
188 €



ESCAZO20EX15Z
256 €



ESCAZO60EX15Z
278 €



ESPZEXCAV15Z
358 €



EXAHYEXCAV15Z
1.300 €

MOTOBOMBAS Y GENERADORES

Motobombas PTO

PTO Water pump / Pompe à cardan / Bombas de motor PTO



3600 rpm. PTO: 540 Succión: 7 m. Presión: 5 bar.	3600 rpm. PTO: 540 Hateur d'aspiration: 7 m. Pression: 5 bar.	3600 rpm. PTO: 540 Succção: 7 m. Pressão: 5 bar.	3600 rpm. PTO: 540 Suction tube: 7 m. Pressure: 5bar.
---	--	---	--

Referencia	hp	m ³ /h	mts	Kg	g cc	mm	€
ES70609	12-125	60	28	66	3	660 x 660 x 880	735 €
ES70619	15-125	80	25	70	4	660 x 660 x 880	798 €
ES70620	25-125	200	15	85	6	760 x 760 x 1000	1.307 €



Generadores PTO

PTO generator / Groupe électrogène à cardan / Geradores PTO



Frecuencia: 50 hz Voltaje: 260 v PTO: 540 (1"3/8 Z6)	Fréquence: 50 hz Tension: 230 v PTO: 540 (1"3/8 z6)	Frequência: 50hz Voltagem: 230 v PTO 540 (1"3/8 z6)	Frequency: 50hz Voltage: 230 v PTO 540 (1"3/8 z6)
--	---	---	---



Referencia	hp	rpm	KW	Kg	mm	€
ES70598	12-125	3000	5	80	660 x 660 x 880	848 €
ES70599	15-125	3000	10	150	660 x 660 x 880	1.502 €
ES70607	15-125	3000	12	155	660 x 660 x 880	1.549 €
ES70608	25-125	1500	24	295	1030 x 750 x 1150	2.651 €

Generadores Trifásicos

Triphasic generator / Groupe électrogène triphasic / Geradores trifásicos

GZ 8000T

13 HP

Gasolina
Arranque Eléctrico

Motor 4T A.E.
Salida Máx. 7,25 kVA
Salida Continua 6,75 kVA
Voltaje 380V y 220V
Depósito 25 L.
Frecuencia 50 Hz
86 Kg.
Carro de transporte.



Referencia	€
ESGN8.0ELCT	839 €

7,25 KVAS

GZ 7500ST

10 HP

Diesel AVR
Arranque Eléctrico

Motor DIESEL 10HP
Salida Máx. 7,5 kVA
Salida Continua 7 kVA
Voltaje 380V y 220V
Depósito 20 L.
Frecuencia 50 Hz
158 Kg.
Carro de transporte.



Referencia	€
ESGNSIL7.5ELZ	1.538 €

7,5 KVAS

ZEPPELIN[®]
el poder de la tierra

ZEPPELIN®

el poder de la tierra

SEDE CENTRAL

Plataforma Logística Zaragoza PLAZA
c/ Tarento, 12 - 50197 ZARAGOZA (Spain)
Tel.: +34 876 269 494 - Fax: +34 876 269 495

CENTRO LOGÍSTICO I

Polígono Industrial Malpica
C/ E. Nave 7 - 50016 ZARAGOZA (Spain)
Tel.: +34 662 147 567

CENTRO LOGÍSTICO II

Avda. Benigno Rivera, n.º 6
27003 LUGO (Spain)
Tels.: +34 982 256 727 · +34 639 955 747

	Dimensiones Dimensions		Reforzado / Reinforced / Renforcé / Renforcado		Nº de discos Number of disc Nb. disques		Notas Notes		Anchura de pala Bucket width Largeur de godet		D ⁰⁰ Despeje Clearance Défriche		PTO r/min	Rotaciones del eje TDF Task speed PTO Vitesse de prise de force		Kg Capacidad Capacity Capacité
	Peso estructura Structure weight Poids de la structure		Desplazable / Side Shift / Déportable / Descantamiento		Largura total Overall length Longueur		Velocidad de giro Swing speed Vitesse de rotation		Largo Length Longueur		Rodillo Roller Rouleau		ha/h	Rendimiento Performance Rendement		Contenido tolva Content of the hopper Contenu de trémie
	Ancho de trabajo Working width Largeur de travail		Reversible / Reversible / Réversible / Réversibel		Anchura de transporte Transport width Largeur de transport		Potencia Power Puissance nécessaire		Prof. Área de trabajo Working depth Profondeur de travail		Peso sin rodillo Weight without roller Poids sans rouleau		hp	Motor Engine Moteur		Capacidad tolva Capacity of the hopper Capacité de trémie
	Mertillos Hammers Fléaux		Ángulo de inclinación (ascendente) Tilt angle (up) Angle d'inclinaison (ascendant)		Número de brazos Number of arms Nº. bras		Motor Engine Moteur		Tamaño pluma Jib size Taille de la bras		Peso con rodillo Weight with roller Poids avec rouleau		Cap. depósito Cap. tank Capacité		Díámetro paca Bale diameter Diamètre de la balle	
	Cuchillas Blades Nb. couteaux		Ángulo de inclinación (descendente) Tilt angle (down) Angle d'inclinaison (descendant)		Ancho de trabajo mín. Min. working width Largeur de travail min.		Potencia Power Puissance		Caja de cambios Gear box Boîte de vitesse		Nº brazos Arms Distance bras		Manguera Hose Tuyau		Nº de muelles Springs Nb. ressorts	
	Cadenas Chains / Chaines Corrétes		Distancia de extensión horizontal Horizontal extension distance Distance d'extension horizontale		Ancho de trabajo máx. Max. working width Largeur de travail máx.		Categoría Category Catégorie		Ancho de transporte Transport width Largeur transporter		Presión de trabajo Working pressure Pression de travail		Pistola Nozzle Pistolet		Enganche Coupling Attelage	
	Rendimiento/eficiencia Performance/efficiency Performances/efficacité		Distancia de extensión vertical Vertical extension distance Distance d'extension verticale		Caudal Débit		Anchura estabilizador Stabilizer width Largeur stabilisateur		Sección brazos Arms section Section bras		Nº de discos Number of discs Nb. disques		Ruedas Wheels Roues		Metros Meters Mètres	
	PTO r/min		Ancho Width Largeur		Capacidad mín. bomba Min. pump capacity Capacité de la pompe min.		Ángulo de la pluma Boom angle Angle de bras		Díámetro del disco Diameter disks Diamètre de disques		PTO r/min		Manguera Hose Tuyau		Enganche Coupling Attelage	
	Potencia mín. requerida Recommended power Puissance nécessaire		Ang. máx. giro Angle max. turn Angle de rotation max.													

Leyenda
Icons
Icônes

Entra en nuestra web y descubre el mundo **ZEPPELIN**
www.zepelinmaquinaria.es